

### DESCRIPTION

The MP5094 is a protection device designed to protect circuitry on the output from transients on the input. The MP5094 also protects the input from undesired shorts and transients coming from the output. The MP5094 is a small  $R_{DS(ON)}$ , low quiescent current, dual-channel, current-limited switch.

During start-up, the inrush current is limited by limiting the slew rate at the output. The slew rate is controlled by a capacitor at the SS pin.

The maximum load at the output is current-limited. The magnitude of the current limit is fixed internally.

The output voltage is limited by an output over-voltage protection (OVP) function.

The MP5094 is available in a space-saving, 8-pin, TSOT23 (3mmx3mm) package.

### FEATURES

- Integrated 5V, 12V Input Dual E-Fuse
- 24V 100ms Maximum Surge Input Voltage Tolerance for 12V Bus
- 16V 100ms Maximum Surge Input Voltage Tolerance for 5V Bus
- Integrated Dual-Channel Current-Limit Switch
- 50mΩ/30mΩ Low  $R_{DS(ON)}$  for 12V Bus/5V Bus Current-Limit Switch
- 110μA Typical Low Quiescent Current for 12V Bus/5V Bus
- Adjustable Soft-Start Time
- Fixed 4A/2.95A Trip/Hold Current Limit for 12V Bus
- Fixed 3A/2.18A Trip/Hold Current Limit for 5V Bus
- Over-Current Protection (OCP) Hiccup
- Latch-Off Thermal Shutdown
- Available in a TSOT23-8 Package

### APPLICATIONS

- Hard Disk Drives
- Solid-State Drives
- Hot Swap

All MPS parts are lead-free, halogen-free, and adhere to the RoHS directive. For MPS green status, please visit the MPS website under Quality Assurance. "MPS", the MPS logo, and "Simple, Easy Solutions" are trademarks of Monolithic Power Systems, Inc. or its subsidiaries.

### TYPICAL APPLICATION

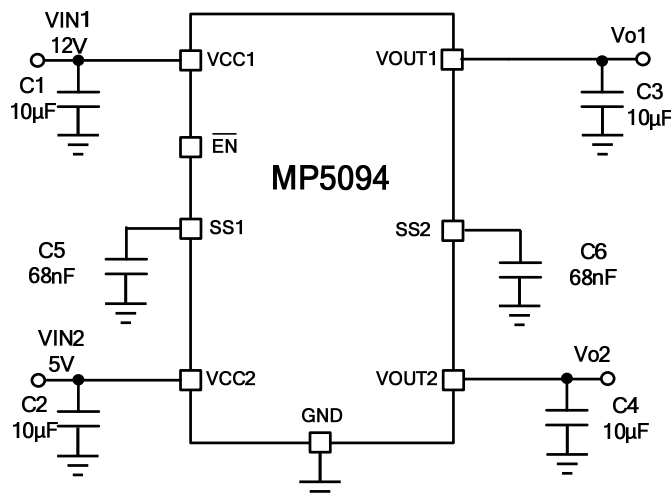

### ORDERING INFORMATION

Part Number*	Package	Top Marking
MP5094GJ	TSOT23-8 (3mmx3mm)	See Below

\* For Tape & Reel, add suffix -Z (e.g. MP5094GJ-Z).

### TOP MARKING

|AYUY

AYU: Product code of MP5094GJ  
 Y: Year code

### PACKAGE REFERENCE

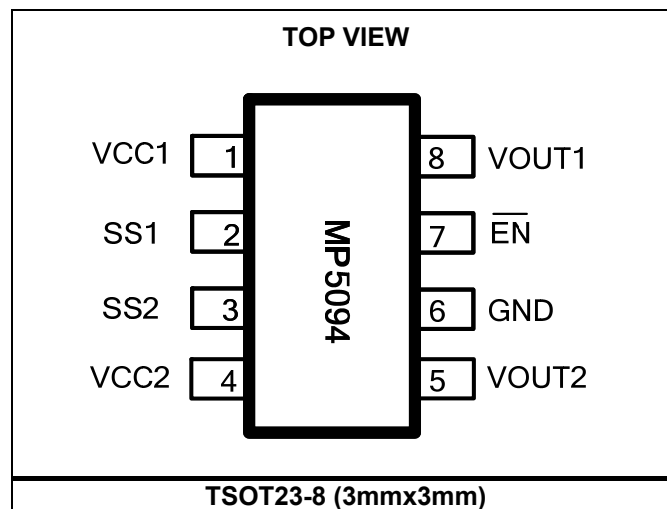

**PIN FUNCTIONS**

Pin #	Name	Description
1	VCC1	<b>Supply voltage of channel 1.</b> The channel 1 typical input voltage is 12V. Use a ceramic capacitor to decouple the input rail. Connect VCC1 using a wide PCB trace.
2	SS1	<b>Channel 1 soft-start pin.</b> Connect a capacitor from SS1 to ground to set the soft-start time.
3	SS2	<b>Channel 2 soft-start pin.</b> Connect a capacitor from SS2 to ground to set the soft-start time.
4	VCC2	<b>Supply voltage of channel 2.</b> The channel 2 typical input voltage is 5V. Use a ceramic capacitor to decouple the input rail. Connect VCC2 using a wide PCB trace.
5	VOUT2	<b>Output terminal of channel 2.</b>
6	GND	<b>System ground.</b>
7	$\overline{\text{EN}}$	<b>Enable pin for channel 1 and channel 2.</b> $\overline{\text{EN}}$ is a digital input that turns the regulator on or off. Float $\overline{\text{EN}}$ or drive $\overline{\text{EN}}$ low to turn on the regulator. Drive $\overline{\text{EN}}$ high to turn off the regulator.
8	VOUT1	<b>Output terminal of the channel 1.</b>

**ABSOLUTE MAXIMUM RATINGS <sup>(1)</sup>**

VCC1, VOUT1 .....	-0.3V to 22V
Input voltage transient (Ch1 100ms) .....	24V
VCC2, VOUT2 .....	-0.3V to 15V
Input voltage transient (Ch2 100ms) .....	16V
All other pins .....	-0.3V to +5V
Junction temperature .....	-40°C to +150°C
Lead temperature .....	260°C
Continuous power dissipation (T <sub>A</sub> = +25°C) <sup>(2)</sup>	
TSOT23-8 (3mmx3mm) .....	1.89W

**Recommended Operating Conditions <sup>(3)</sup>**

Ch1 continuous supply voltage...	10.2V to 14.5V
Ch2 continuous supply voltage.....	4.6V to 5.5V
Operating junction temp. (T <sub>J</sub> ).....	-40°C to +125°C

Thermal Resistance	$\theta_{JA}$	$\theta_{JC}$
TSOT23-8		
EV5094-J-00A <sup>(4)</sup> .....	66	23 ... °C/W
JESD51-7 <sup>(5)</sup> .....	100	55 ... °C/W

**NOTES:**

- Exceeding these ratings may damage the device.
- The maximum allowable power dissipation is a function of the maximum junction temperature T<sub>J</sub> (MAX), the junction-to-ambient thermal resistance  $\theta_{JA}$ , and the ambient temperature T<sub>A</sub>. The maximum allowable continuous power dissipation of EV5094-J-00A board at any ambient temperature is calculated by P<sub>D</sub> (MAX) = (T<sub>J</sub> (MAX)-T<sub>A</sub>)/ $\theta_{JA}$ . Exceeding the maximum allowable power dissipation produces an excessive die temperature, causing the regulator to go into thermal shutdown. Internal thermal shutdown circuitry protects the device from permanent damage. Here, the max power of the TSOT23-8 is given by  $\theta_{JA}$  on EV5094-J-00A.
- The device is not guaranteed to function outside of its operating conditions.
- Measured on EV5094-J-00A, 2-layer PCB, 54mmx46mm.
- The value of  $\theta_{JA}$  given in this table is only valid for comparison with other packages and cannot be used for design purposes. These values were calculated in accordance with JESD51-7 and simulated on a specified JEDEC board. They do not represent the performance obtained in an actual application.

## ELECTRICAL CHARACTERISTICS

$V_{IN1} = 12V$ ,  $V_{IN2} = 5V$ ,  $C_{OUT1} = C_{OUT2} = 10\mu F$ ,  $T_J = -40^{\circ}C + 125^{\circ}C$  <sup>(6)</sup>, typical value is tested at  $T_J = +25^{\circ}C$  unless otherwise noted.

Parameter	Symbol	Condition	Min	Typ	Max	Units
<b>Supply Current</b>						
Quiescent current	$I_{Q\_CH1}$	$V_{\overline{EN}} = \text{low}$		110		$\mu A$
		$V_{\overline{EN}} = \text{high}$		10		$\mu A$
	$I_{Q\_CH2}$	$V_{\overline{EN}} = \text{low}$		110		$\mu A$
		$V_{\overline{EN}} = \text{high}$		6.5		$\mu A$
Off-state leakage current	$I_{OFF}$	$V_{IN} = 14V$ , $V_{\overline{EN}} = 2V$			1	$\mu A$
<b>Power MOSFET</b>						
On resistance	$R_{DS(ON)\_CH1}$	$T_J = 25^{\circ}C$		50		$m\Omega$
		$T_J = 125^{\circ}C$			70	$m\Omega$
	$R_{DS(ON)\_CH2}$	$T_J = 25^{\circ}C$		30		$m\Omega$
		$T_J = 125^{\circ}C$			50	$m\Omega$
Turn-on delay <sup>(7)</sup>	$T_{delay\_CH1}$	$V_{\overline{EN}} = 0V$ to $V_o$ begins ramping up with a 3A load resistor		690		$\mu s$
	$T_{delay\_CH2}$	$V_{\overline{EN}} = 0V$ to $V_o$ begins ramping up with a 2A load resistor		690		$\mu s$
<b>Under-/Over-Voltage Protection (UVP, OVP)</b>						
Under-voltage lockout rising threshold	$V_{UVLO\_CH1}$		9.2	9.7	10.2	V
	$V_{UVLO\_CH2}$		4.1	4.4	4.6	V
UVLO hysteresis	$V_{UVLOHYS\_CH1}$			800		mV
	$V_{UVLOHYS\_CH2}$			1.7		V
Output over-voltage clamp voltage	$V_{OVLO\_CH1}$		14.5	15	15.5	V
	$V_{OVLO\_CH2}$		5.5	5.7	6.0	V
Output over-voltage response time <sup>(7)</sup>	$t_{OUT\_OV\_CH1}$	$C_{OUT} = 10\mu F$ , add a 30 $\Omega$ load resistor, $V_{IN1} = 12V$ to 18V/10 $\mu s$		2		$\mu s$
	$t_{OUT\_OV\_CH2}$	$C_{OUT} = 10\mu F$ , add a 10 $\Omega$ load resistor, $V_{IN2} = 5V$ to 7V/10 $\mu s$		2		$\mu s$
<b>Current Limit</b>						
Current limit at normal operation	$I_{Limit\_NO\_CH1\_TRIP}$		3.6	4	4.4	A
	$I_{Limit\_NO\_CH2\_TRIP}$		2.65	2.95	3.25	A
	$I_{Limit\_SC\_CH1\_Hold}$		2.7	3	3.3	A
	$I_{Limit\_SC\_CH2\_Hold}$		1.95	2.18	2.4	A
Current limit response time <sup>(7)</sup>	$t_{CL\_CH1}$			15		$\mu s$
	$t_{CL\_CH2}$			15		$\mu s$
Secondary current limit <sup>(7)</sup>	$I_{LimitH\_CH1}$			8		A
	$I_{LimitH\_CH2}$			8		A

**ELECTRICAL CHARACTERISTICS (continued)**

$V_{IN1} = 12V$ ,  $V_{IN2} = 5V$ ,  $C_{OUT1} = C_{OUT2} = 10\mu F$ ,  $T_J = -40^{\circ}C + 125^{\circ}C$  <sup>(6)</sup>, typical value is tested at  $T_J = +25^{\circ}C$  unless otherwise noted.

Parameter	Symbol	Condition	Min	Typ	Max	Units
<b>Enable</b>						
$\overline{EN}$ falling threshold	$V_{\overline{EN\_Falling}}$					
$\overline{EN}$ hysteresis	$V_{\overline{EN\_HYS}}$			250		mV
$\overline{EN}$ pull-down resistor	$R_{\overline{EN\_PD}}$			280		K $\Omega$
<b>Soft Start</b>						
SS current	$I_{SS\_CH1}$		4	5.5	7	$\mu A$
	$I_{SS\_CH2}$		4	5.5	7	$\mu A$
<b>OTP</b>						
Thermal shutdown <sup>(7)</sup>	$T_{SD}$			155		$^{\circ}C$

**NOTES:**

- 6) Not tested in production, guaranteed by over-temperature correlation.  
 7) Guaranteed by design and engineering sample characterization.

**TYPICAL PERFORMANCE CHARACTERISTICS**
 $V_{IN1} = 12V$ ,  $V_{IN2} = 5V$ ,  $V_{EN} = \text{float}$ ,  $T_A = 25^\circ\text{C}$ , unless otherwise noted.

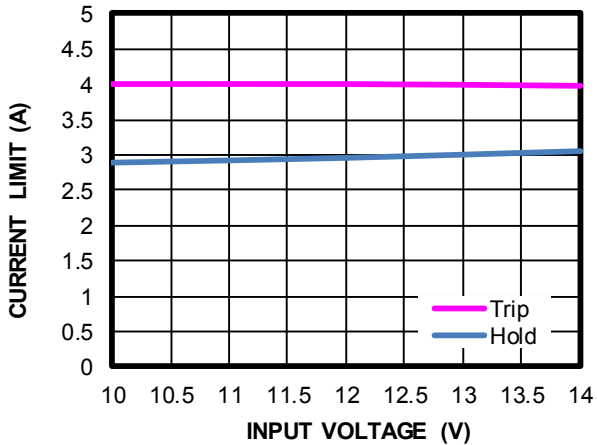
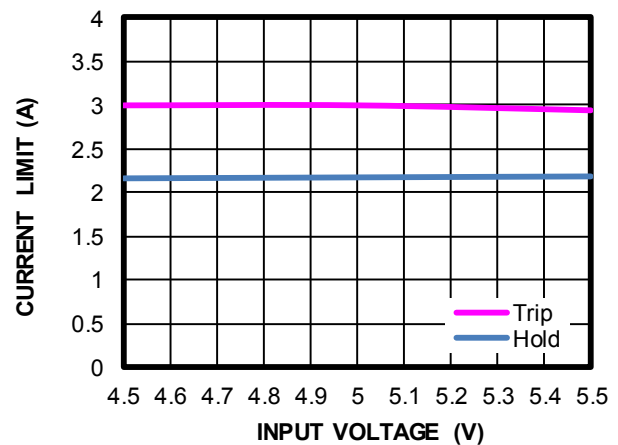
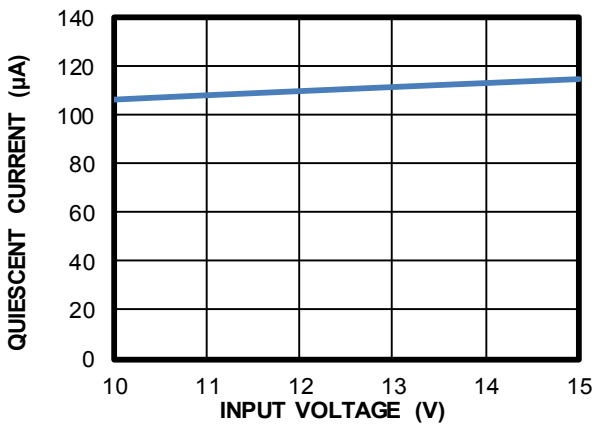
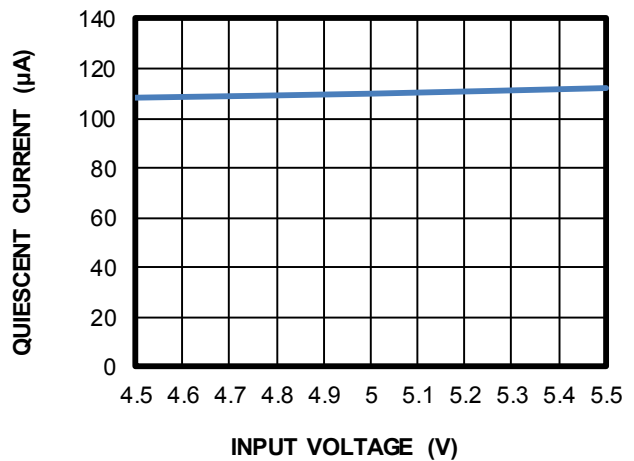
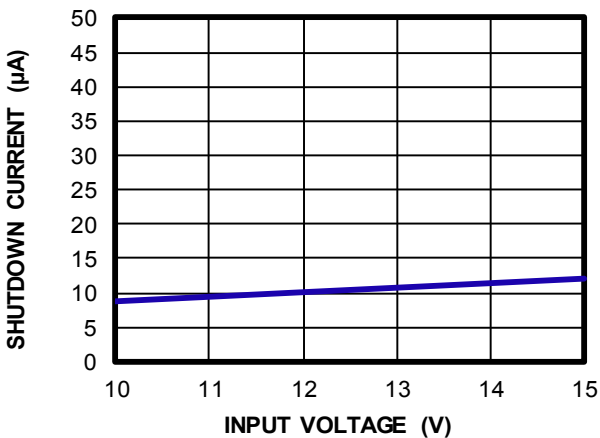
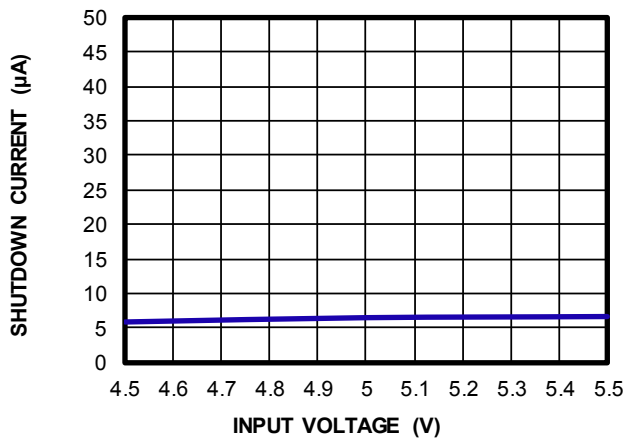
**Current Limit vs. Input Voltage (12V E-Fuse)**

**Current Limit vs. Input Voltage (5V E-Fuse)**

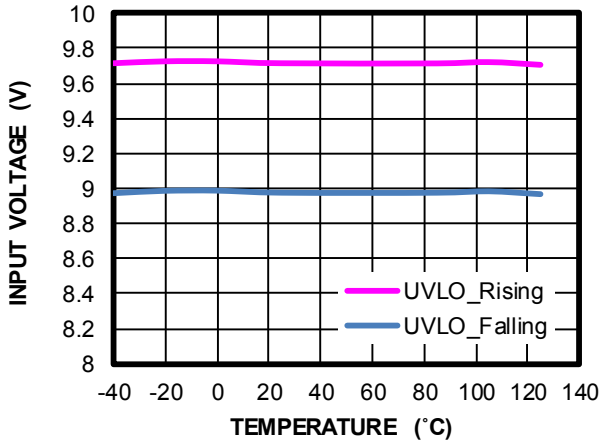
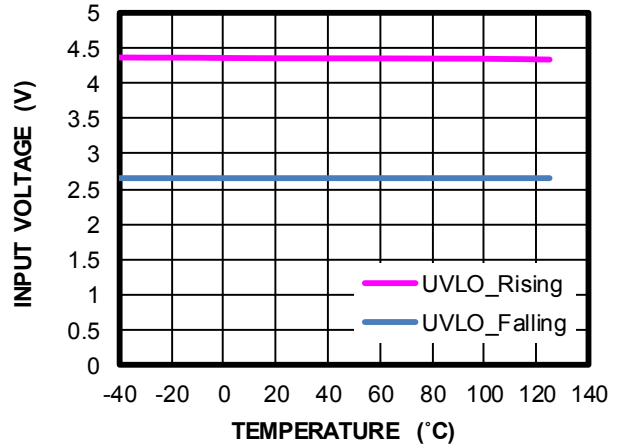
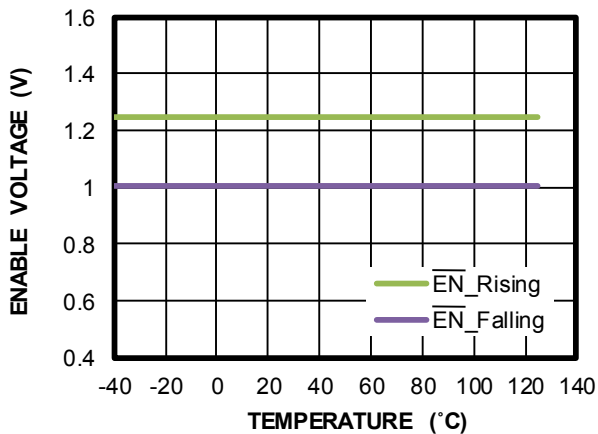
**Quiescent Current vs. Input Voltage (12V E-Fuse)**

**Quiescent Current vs. Input Voltage (5V E-Fuse)**

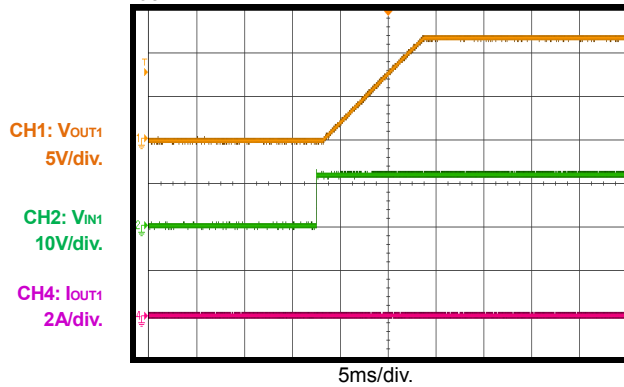
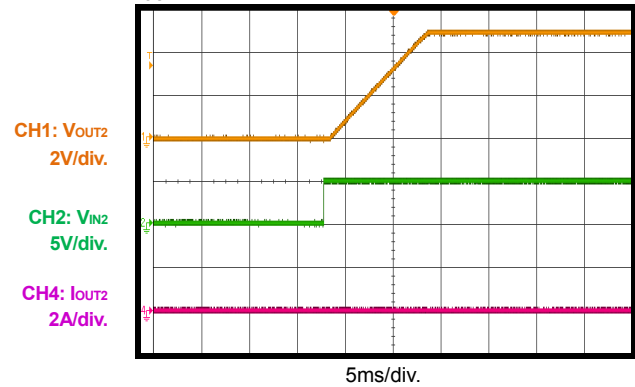
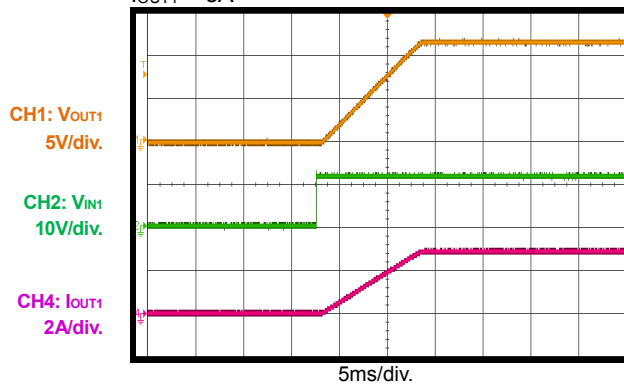
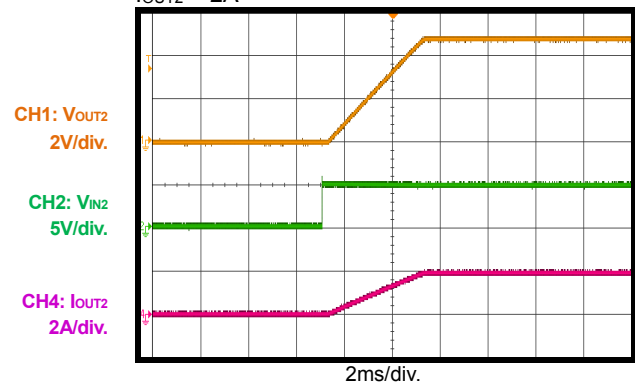
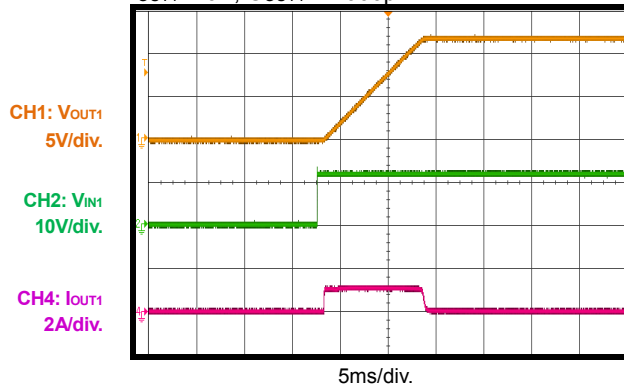
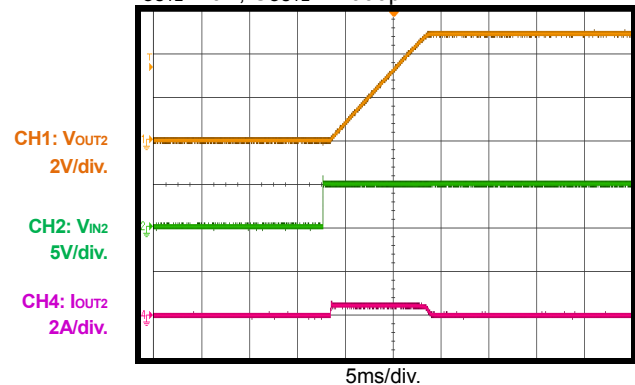
**Shutdown Current vs. Input Voltage (12V E-Fuse)**
 $V_{EN} = 3.3V$ 

**Shutdown Current vs. Input Voltage (5V E-Fuse)**
 $V_{EN} = 3.3V$ 

**TYPICAL PERFORMANCE CHARACTERISTICS (continued)**
 $V_{IN1} = 12V$ ,  $V_{IN2} = 5V$ ,  $V_{EN} = \text{float}$ ,  $T_A = 25^\circ\text{C}$ , unless otherwise noted.

 **$V_{IN}$  UVLO Rising/Falling Threshold vs. Temperature (12V E-Fuse)**  
 $T_A = -40^\circ\text{C}$  to  $+125^\circ\text{C}$ 

 **$V_{IN}$  UVLO Rising/Falling Threshold vs. Temperature (5V E-Fuse)**  
 $T_A = -40^\circ\text{C}$  to  $+125^\circ\text{C}$ 

 **$\overline{EN}$  Rising/Falling Threshold vs. Temperature**  
 $T_A = -40^\circ\text{C}$  to  $+125^\circ\text{C}$ 

**TYPICAL PERFORMANCE CHARACTERISTICS (continued)**
 $V_{IN1} = 12V$ ,  $V_{IN2} = 5V$ ,  $V_{EN} = \text{float}$ ,  $T_A = 25^\circ\text{C}$ , unless otherwise noted.

**Start-Up through Input Voltage (12V E-Fuse)**
 $I_{OUT1} = 0A$ 

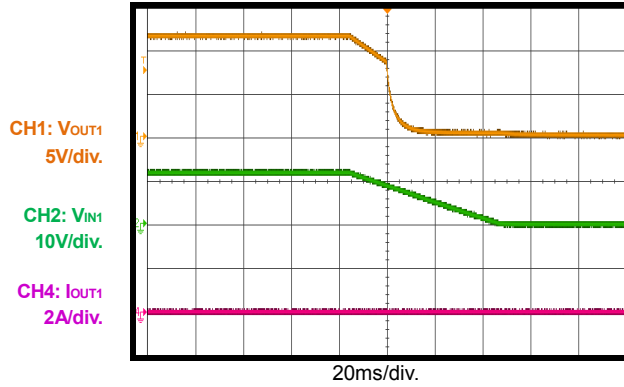
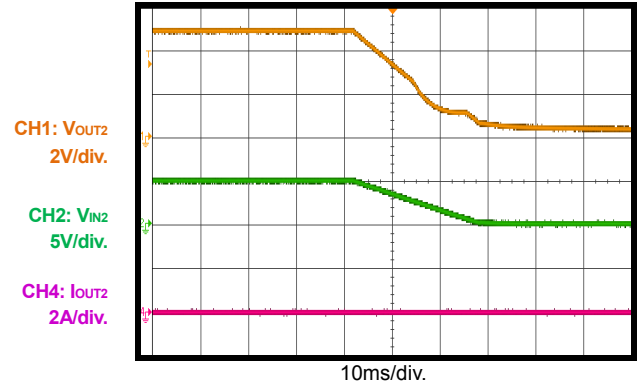
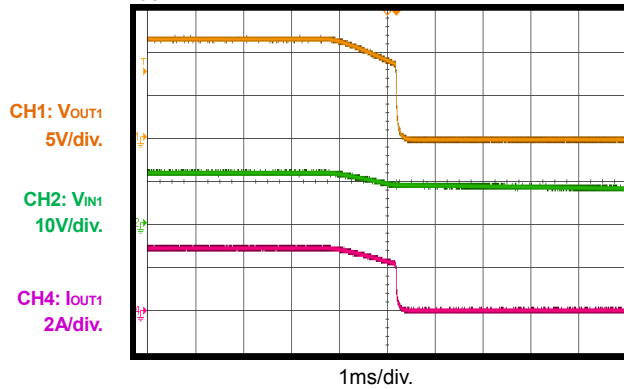
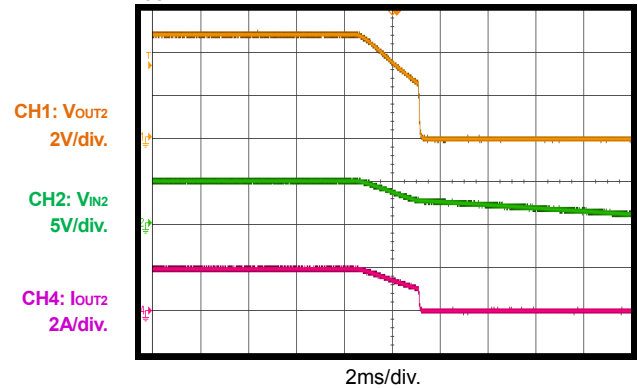
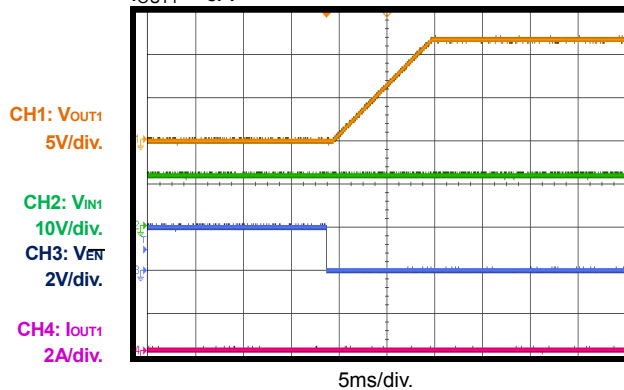
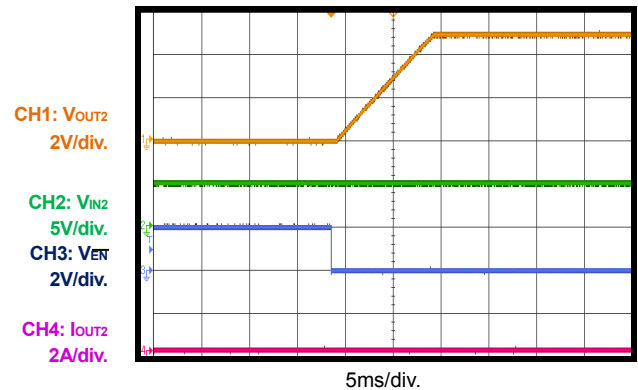
**Start-Up through Input Voltage (5V E-Fuse)**
 $I_{OUT2} = 0A$ 

**Start-Up through Input Voltage (12V E-Fuse)**
 $I_{OUT1} = 3A$ 

**Start-Up through Input Voltage (5V E-Fuse)**
 $I_{OUT2} = 2A$ 

**Start-Up through Input Voltage (12V E-Fuse)**
 $I_{OUT1} = 0A$ ,  $C_{OUT1} = 1000\mu F$ 

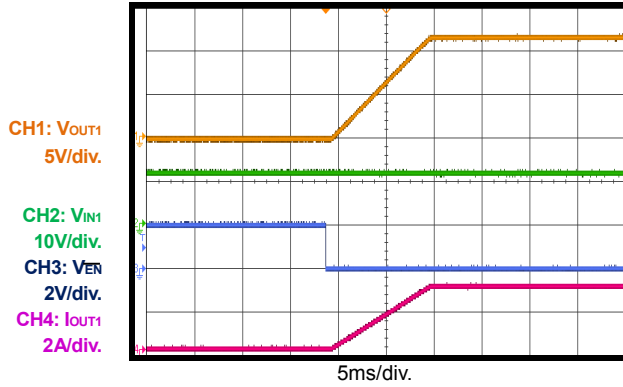
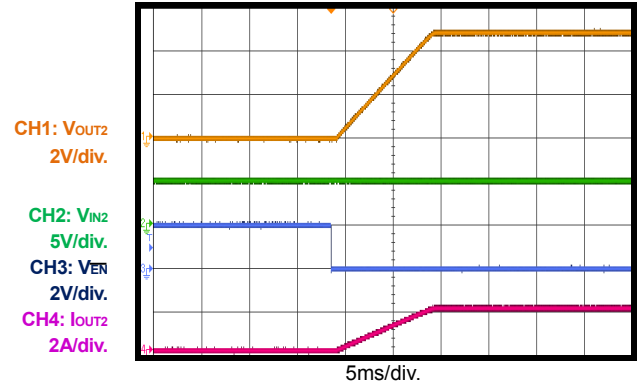
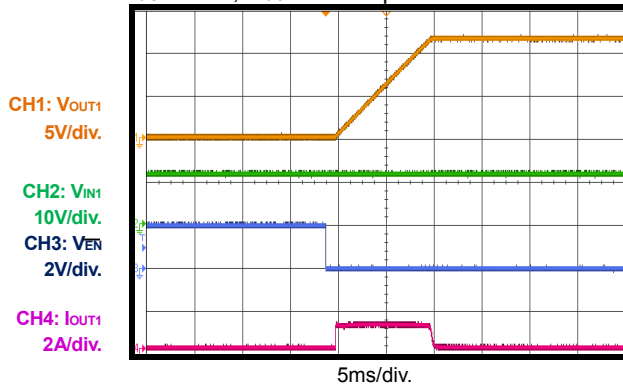
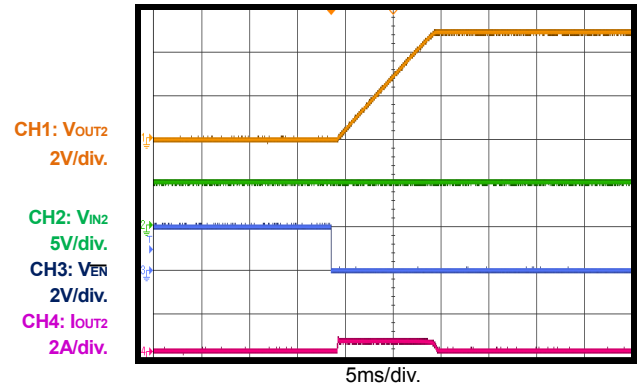
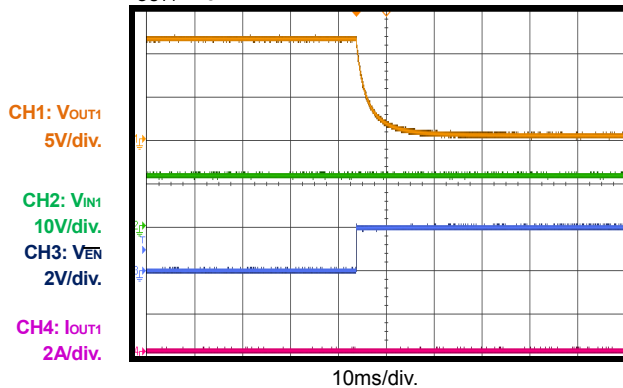
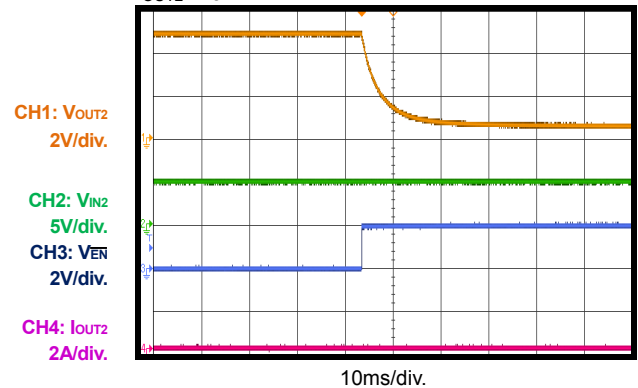
**Start-Up through Input Voltage (5V E-Fuse)**
 $I_{OUT2} = 0A$ ,  $C_{OUT2} = 1000\mu F$ 



**TYPICAL PERFORMANCE CHARACTERISTICS (continued)**
 $V_{IN1} = 12V$ ,  $V_{IN2} = 5V$ ,  $V_{EN} = \text{float}$ ,  $T_A = 25^\circ\text{C}$ , unless otherwise noted.

**Shutdown through Input Voltage (12V E-Fuse)**
 $I_{OUT1} = 0A$ 

**Shutdown through Input Voltage (5V E-Fuse)**
 $I_{OUT2} = 0A$ 

**Shutdown through Input Voltage (12V E-Fuse)**
 $I_{OUT1} = 3A$ 

**Shutdown through Input Voltage (5V E-Fuse)**
 $I_{OUT2} = 2A$ 

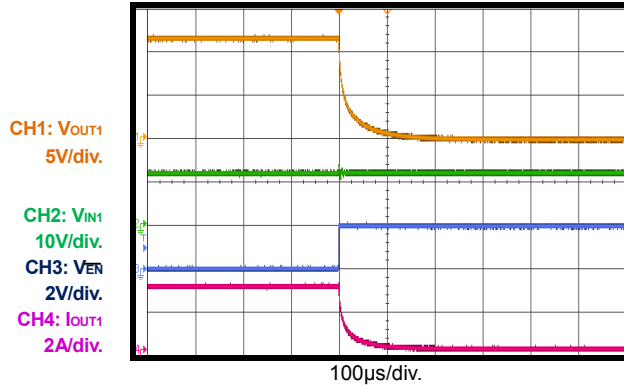
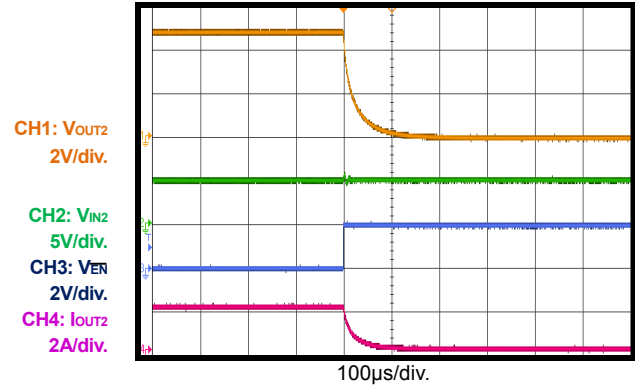
**Start-Up through Enable (12V E-Fuse)**
 $I_{OUT1} = 0A$ 

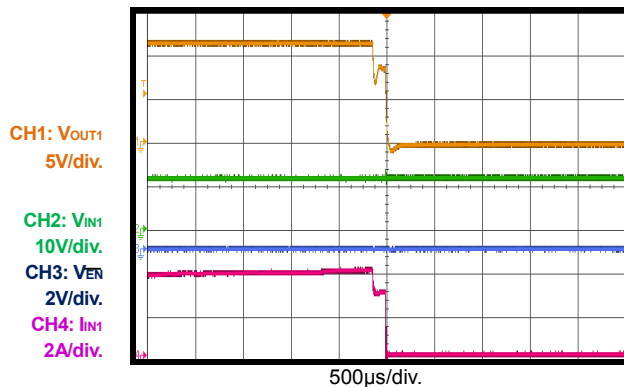
**Start-Up through Enable (5V E-Fuse)**
 $I_{OUT2} = 0A$ 

**TYPICAL PERFORMANCE CHARACTERISTICS (continued)**
 $V_{IN1} = 12V$ ,  $V_{IN2} = 5V$ ,  $V_{EN} = \text{float}$ ,  $T_A = 25^\circ\text{C}$ , unless otherwise noted.

**Start-Up through Enable (12V E-Fuse)**
 $I_{OUT1} = 3A$ 

**Start-Up through Enable (5V E-Fuse)**
 $I_{OUT2} = 2A$ 

**Start-Up through Enable (12V E-Fuse)**
 $I_{OUT1} = 0A$ ,  $C_{OUT1} = 1000\mu\text{F}$ 

**Start-Up through Enable (5V E-Fuse)**
 $I_{OUT2} = 0A$ ,  $C_{OUT2} = 1000\mu\text{F}$ 

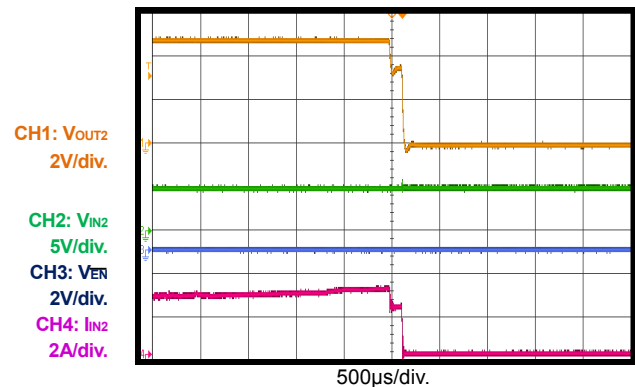
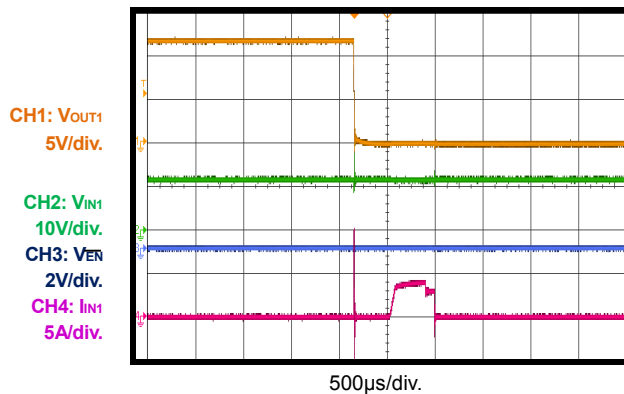
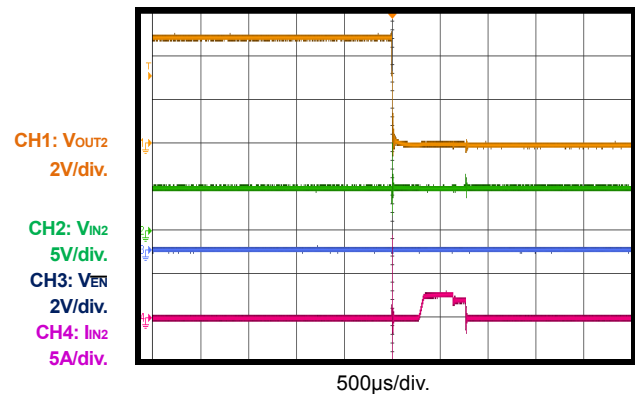
**Shutdown through Enable (12V E-Fuse)**
 $I_{OUT1} = 0A$ 

**Shutdown through Enable (5V E-Fuse)**
 $I_{OUT2} = 0A$ 

**TYPICAL PERFORMANCE CHARACTERISTICS (continued)**
 $V_{IN1} = 12V$ ,  $V_{IN2} = 5V$ ,  $V_{EN} = \text{float}$ ,  $T_A = 25^\circ\text{C}$ , unless otherwise noted.

**Shutdown through Enable (12V E-Fuse)**
 $I_{OUT1} = 3A$ 

**Shutdown through Enable (5V E-Fuse)**
 $I_{OUT2} = 2A$ 

**Current Limit (12V E-Fuse)**

 Increase  $I_{OUT1}$  slowly

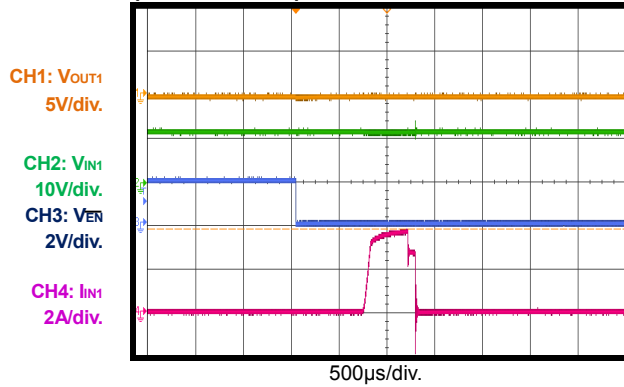
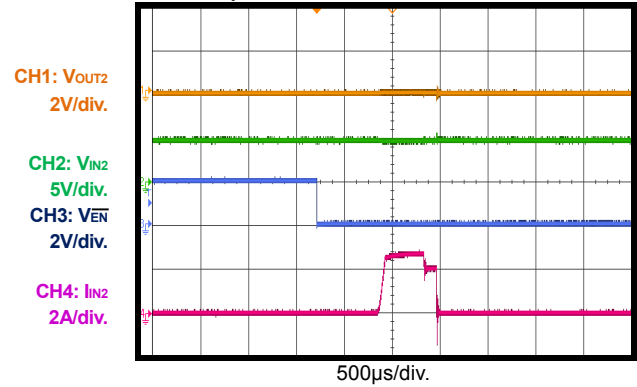
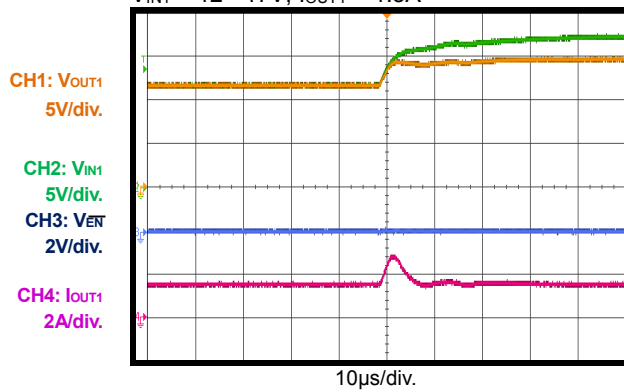
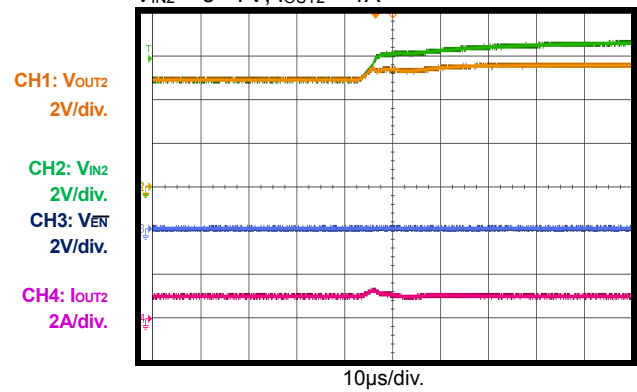
**Current Limit (5V E-Fuse)**

 Increase  $I_{OUT2}$  slowly

**Short Circuit during Normal Operation (12V E-Fuse)**

**Short Circuit during Normal Operation (5V E-Fuse)**

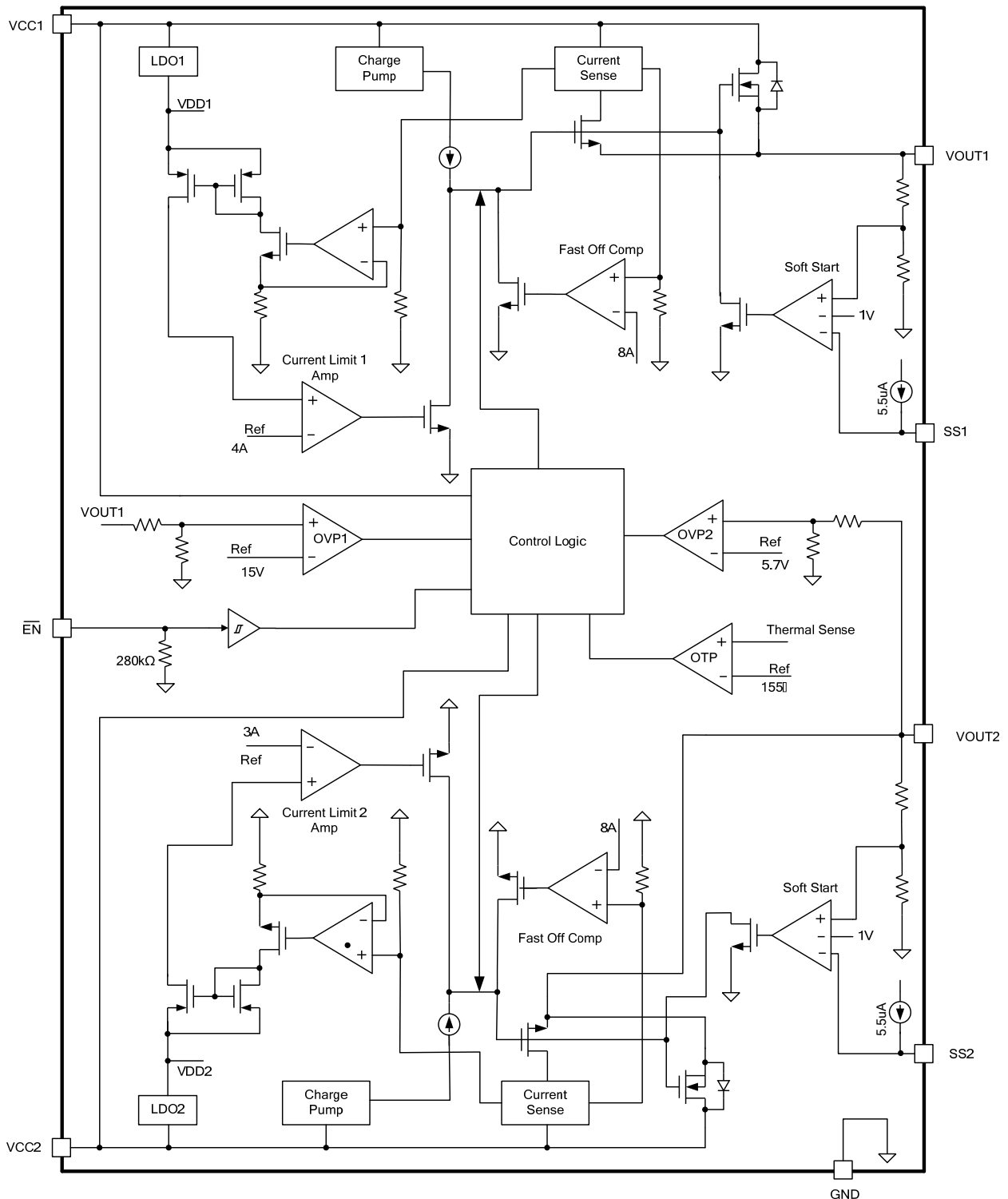
**TYPICAL PERFORMANCE CHARACTERISTICS (continued)**
 $V_{IN1} = 12V$ ,  $V_{IN2} = 5V$ ,  $V_{EN} = \text{float}$ ,  $T_A = 25^\circ\text{C}$ , unless otherwise noted.

**Short Circuit before  $\overline{EN}$  Start-Up (12V E-Fuse)**

**Short Circuit before  $\overline{EN}$  Start-Up (5V E-Fuse)**

**Output Over-Voltage Protection (12V E-Fuse)**
 $V_{IN1} = 12 - 17V$ ,  $I_{OUT1} = 1.5A$ 

**Output Over-Voltage Protection (5V E-Fuse)**
 $V_{IN2} = 5 - 7V$ ,  $I_{OUT2} = 1A$ 

**BLOCK DIAGRAM**



**Figure 1: Functional Block Diagram**

## OPERATION

The MP5094 is a dual-channel, current-limited switch designed to limit inrush current to the load when a circuit card is inserted into a live backplane power source. This limits the backplane's voltage drop and the dV/dt of the voltage to the load. The MP5094 offers an integrated solution to monitor input voltage, output voltage, output current, and die temperature, which eliminates the need for an external current-sense power resistor, power MOSFET, and thermal sense device.

### Under-Voltage Lockout (UVLO)

Channel 1 can be used in the 12V input supply system, and channel 2 can be used in the 5V input supply system. High-energy transients can occur during normal operation or during a hot swap. These transients depend on the parasitic inductance and resistance of the wire and the capacitor at the VCC node. If the power clamp (TVS, Tranzorb) diode is not used, the E-fuse must be able to withstand this transient voltage. The MP5094 has an integrated high-voltage MOSFET and uses a high-voltage circuit for the VCC node to guarantee safe operation.

If the supply (input) is below the under-voltage lockout (UVLO) threshold, the output is disabled. When the supply goes above the UVLO threshold, the output is enabled.

### Soft Start (SS)

Connect a capacitor to the soft-start pin (SS) to set the soft-start time. A constant-current source charges the SS capacitor and generates a linear ramping voltage on SS. The output voltage rises at a similar slew rate to the SS voltage.

The soft-start time is a function of the capacitor ( $C_{SS}$ ) and can be calculated with Equation (1):

$$t_{ss} \text{ (ms)} = \frac{1V \times C_{SS} \text{ (nF)}}{5.5\mu\text{A}} \times \frac{V_{INX}}{V_{CLAMPX}} \quad (1)$$

Where  $t_{SS}$  is the soft-start time (from 0 - 100%  $V_{OUT}$ ),  $V_{INX}$  is the input voltage of the current limit switch, and  $V_{CLAMPX}$  is the clamping voltages of the 5V and 12V current limit switches (5.7V and 15V respectively).

### Fast Output Over-Voltage Protection (OVP)

The MP5094 provides an output over-voltage protection (OVP) function to protect the downstream load when there is a surge voltage at the input. An accurate and fast comparator monitors the over-voltage condition of the output. If the output voltage rises above the threshold, the gate of the internal MOSFET is pulled down quickly and is regulated to a certain value to maintain the output voltage clamped at the OVP threshold. The fast loop response speed (typically 2 $\mu$ s) keeps the over-voltage overshoot small.

### Current Limit

When the MP5094 is active, if load reaches the trip current (threshold current triggers over-current protection) or a short is present, the MP5094 switches into constant-current (hold-current) mode. The MP5094 enters hiccup protection mode if the over-current condition remains for longer than 150 $\mu$ s. The MP5094 restarts automatically after 200ms of off time. This operation repeats until the over-current condition is removed.

The channel 1 trip current is set to 4A internally, and the hold current is 2.95A. The channel 2 trip current is set to 3A internally, and the hold current is 2.18A.

### Short-Circuit Protection (SCP)

If the load current increases rapidly due to a short-circuit event, the current may exceed the current-limit threshold before the control loop can respond. If the current reaches the 8A secondary current-limit level, a fast turn-off circuit activates to turn off the power MOSFET. This can help limit the peak current through the switch, keeping the input voltage from dropping too much. The total short-circuit response time is less than 1 $\mu$ s. After the MOSFET is switched off, the MP5094 restarts. During the restart process, if the short still remains, the MP5094 regulates the gate voltage to hold the current at a normal current-limit level. The IC enters hiccup mode with 200ms of off time.

**Enable ( $\overline{\text{EN}}$ )**

$\overline{\text{EN}}$  is a digital control pin that turns the current limit switch on and off. Drive  $\overline{\text{EN}}$  high to turn off the current-limit switch. Drive  $\overline{\text{EN}}$  low to turn on the current-limit switch. An internal 280k $\Omega$  resistor from  $\overline{\text{EN}}$  to GND allows  $\overline{\text{EN}}$  to be floated to turn on the MP5094 automatically.

**Thermal Shutdown**

Thermal shutdown prevents the chip from operating at exceedingly high temperatures. When the silicon die temperature exceeds 155°C, the entire chip shuts down.

## APPLICATION INFORMATION

### Soft-Start Time Setting

The soft-start time is a function of the capacitor ( $C_{SS}$ ). The typical value of this capacitor can be calculated with Equation (2):

$$t_{ss} \text{ (ms)} = \frac{1V \times C_{SS} \text{ (nF)}}{5.5\mu\text{A}} \times \frac{V_{INX}}{V_{CLAMPX}} \quad (2)$$

Where  $t_{ss}$  is the soft-start time (from 0 - 100%  $V_{OUT}$ ),  $V_{INX}$  is the input voltage of the current limit switch, and  $V_{CLAMPX}$  is the clamping voltages of the 5V and 12V current limit switches (5.7V and 15V respectively).

For example, if the external SS capacitor is 68nF, the soft-start time is about 10ms for both the 5V and 12V current-limit switches.

### PCB Layout Guidelines

Efficient PCB layout is critical for stable operation. For best results, refer to Figure 2 and follow the guidelines below.

1. Place the high-current paths (VCC, VOUT) close to the device using short, direct, and wide traces.
2. Place the input capacitors close to the VCC and GND pins.
3. Connect the VCC and VOUT pads to large VCC and VOUT planes respectively for better thermal performance.
4. Place a SS capacitor close to the SS pin.

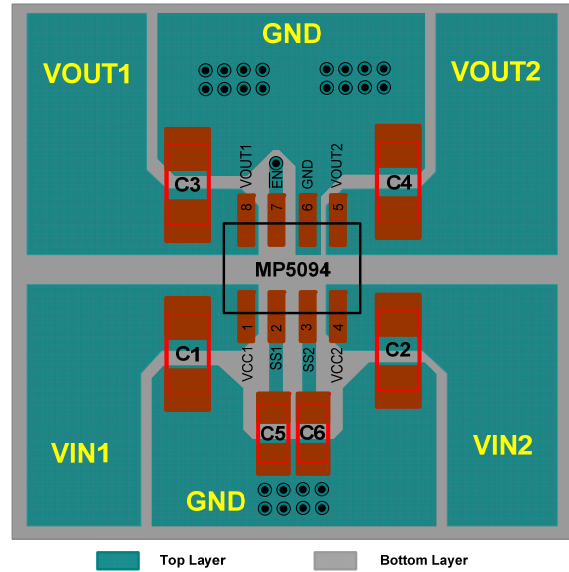

**Figure 2: Recommended Layout**

### Design Example

Table 1 shows a design example following the application guidelines for specifications below.

**Table 1: Design Example**

$V_{IN1}$	12V
$V_{OUT1}$	12V
$V_{IN2}$	5V
$V_{OUT2}$	5V
<b>SS time</b>	10ms

The detailed application circuit is shown in Figure 3. The typical performance and circuit waveforms are shown in the Typical Performance Characteristics section. For more detailed device applications, please refer to the related evaluation board datasheet.



TYPICAL APPLICATION CIRCUITS

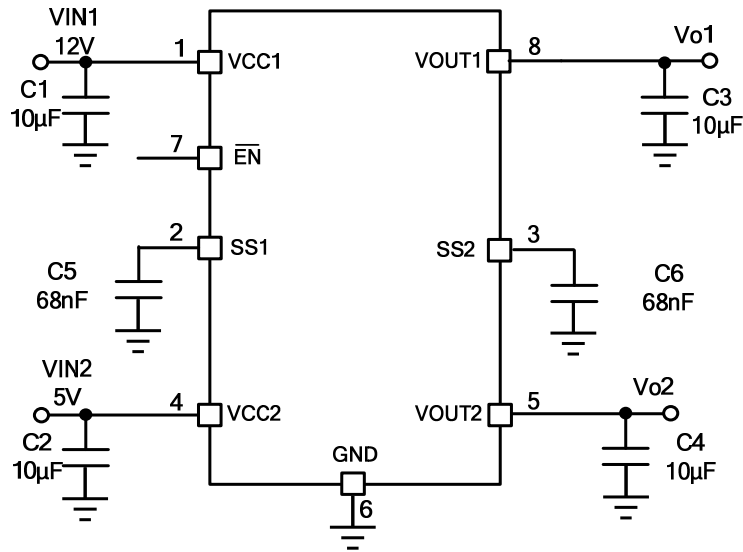
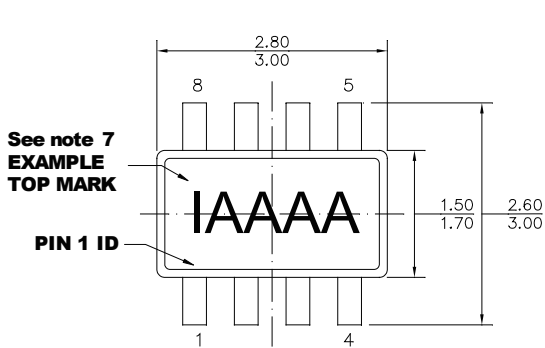

Figure 3: Typical Application Circuit

**PACKAGE INFORMATION**

**TSOT23-8 (3mmx3mm)**



**TOP VIEW**

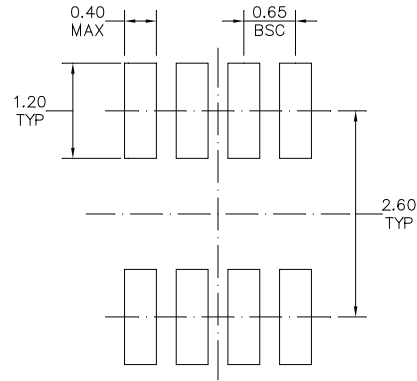

**RECOMMENDED LAND PATTERN**

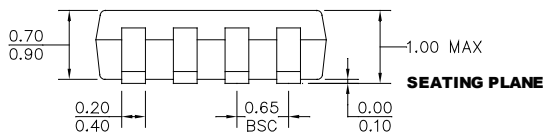

**FRONT VIEW**

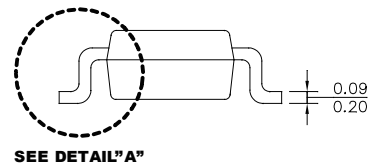

**SIDE VIEW**

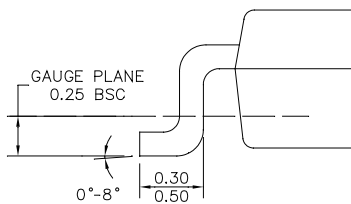

**DETAIL "A"**

**NOTE:**

- 1) ALL DIMENSIONS ARE IN MILLIMETERS
- 2) PACKAGE LENGTH DOES NOT INCLUDE MOLD FLASH, PROTRUSION OR GATE BURR
- 3) PACKAGE WIDTH DOES NOT INCLUDE INTERLEAD FLASH OR PROTRUSION
- 4) LEAD COPLANARITY(BOTTOM OF LEADS AFTER FORMING) SHALL BE 0.10 MILLIMETERS MAX.
- 5) JEDEC REFERENCE IS MQ193, VARIATION BA
- 6) DRAWING IS NOT TO SCALE
- 7) PIN 1 IS LOWER LEFT PIN WHEN READING TOP MARK FROM LEFT TO RIGHT, (SEE EXAMPLE TOP MARK)

**NOTICE:** The information in this document is subject to change without notice. Users should warrant and guarantee that third party Intellectual Property rights are not infringed upon when integrating MPS products into any application. MPS will not assume any legal responsibility for any said applications.