



Among the three families of triple-output DC/DC converters in MPS's A-Series, the 20W 2" x 2" devices are distinguished by their unique "power-sharing" architecture. This feature enables devices to deliver the full 20 Watts of output power under a variety of output-loading conditions.

FEATURES

- Low cost! Highly reliable!
- Full 20 Watts output power
- Power "user-allocated" among outputs
- Proven SMT-on-pcb construction
- Qual tested; HALT tested; EMC tested
- Output voltages: +5V/±12V or +5V/±15V
- Ultra-wide input voltage ranges: 9-36V or 18-75V
- Designed to meet UL1950/EN60950. BASIC insulation (all 48VIN models)
- CE mark available (75V input models)
- Small packages, 2" x 2" x 0.45"
- Fully isolated, 1500Vdc guaranteed
- Guaranteed efficiencies to 82%
- -40 to +100°C operating temperature
- Modifications and customs for OEM's

PRODUCT OVERVIEW

Each unit's primary +5V output can source any current up to 3 Amps (primary power = 15W); while its auxiliary ±12/15V outputs can source currents up to ±500mA (auxiliary power = 12/15W). Devices deliver any combination of primary plus auxiliary power as long as the total output power does not exceed 20 Watts. This feature enables designers to select a single device to fulfill any number of different requirements.

As members of MPS's new A-Series, the 20W triples exhibit both low cost and outstanding long-term reliability. Their design combines straightforward circuit topologies, the newest components, proven SMT-on-pcb construction methods, and highly repeatable automatic-assembly techniques. Their superior

durability is substantiated by a rigorous in-house qualification program that includes HALT (Highly Accelerated Life Testing).

Each device has a +5V primary output and either ±12V or ±15V auxiliary outputs. "D12A" models achieve fully rated performance with inputs ranging from 9 to 36 Volts. "D48A" models operate over an input range of 18-75 Volts.

These full-featured triples have non-latching output current limiting, input overvoltage shutdown, input reverse-polarity protection, and output overvoltage clamping to protect both the power converters and their loads.

SIMPLIFIED SCHEMATIC

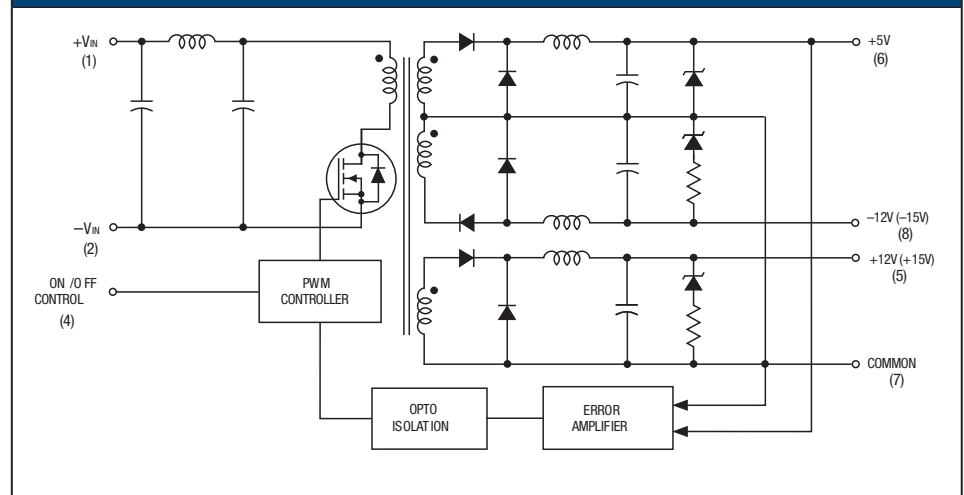

For full details go to
www.murata-ps.com/rohs

PERFORMANCE SPECIFICATIONS SUMMARY AND ORDERING GUIDE ①												
Model Family	Output						Input			Efficiency ^⑤		Package (Case/ Pinout)
	V _{OUT} (V)	I _{OUT} (mA)	R/N (mVp-p) ^②		Regulation ^③		V _{IN} Nom. (Volts)	Range (Volts)	I _{IN} (mA)	Min.	Typ.	
			Typ.	Max.	Line	Load						
Available TWR-5/3000-12/500-D12A-C	+5	3000	50	100	±0.2%	±0.5%	12	9-36	20/1004	81%	82%	C4, P13
	±12	±500	75	125	±0.5%	±6%						
Discontinued TWR-5/3000-12/500-D48A-C	+5	3000	50	100	±1%	±2%	48	18-75	40/559	82%	83%	C4, P13
	±12	±500	75	125	±1%	±5%						
Available TWR-5/3000-15/500-D12A-C	+5	3000	50	100	±0.1%	±0.25%	12	9-36	40/1173	81%	82%	C4, P13
	±15	±500	75	150	±0.5%	±4%						
Discontinued TWR-5/3000-15/500-D48A-C	+5	3000	50	100	±1%	±2%	48	18-75	40/559	81%	82%	C4, P13
	±15	±500	75	150	±1%	±5%						

① Typical @ T_A = +25°C under nominal line voltage and full-load conditions unless otherwise noted. ② For the +5V output, listed spec applies over the 10% to 100% load range. For the ±12/15V outputs, for testing and specification purposes, "full load" is defined as 2.75A on the primary +5V output and listed spec applies for balanced loads over the 20% to 100% load range. ±250/200mA on the auxiliary ±12/15V outputs. This corresponds to a total output power of 19.75W. ③ Nominal line voltage, no-load/full-load conditions.

④ Ripple/Noise (R/N) measured over a 20MHz bandwidth.

PART NUMBER STRUCTURE

TWR-5/3000-15/500-D48A-C

Output Configuration:
T = Triple

Wide Range Input

Nominal Primary Output:
Voltage (+5V)

Maximum Primary Output
Current in mA

Nominal Auxiliary Output:
Voltages (±12 or ±15V)

RoHS-6 compliant*

A-Series
High Reliability

Input Voltage Range:
D12 = 9-36V (12V nominal)
D48 = 18-75V (48V nominal)

Maximum Auxiliary Output:
Currents in mA from each output

* Contact Murata Power Solutions for availability.

MECHANICAL SPECIFICATIONS

INPUT/OUTPUT CONNECTIONS

Pin	Function P13
1	+Input
2	-Input
3	No Pin
4	On/Off Control
5	+12V/15V Output
6	+5V Output
7	Common
8	-12V/15V Output

Note: For "D12A" models, the case is connected to pin 2 (-V_{IN}).
For "D48A" models, the case is connected to pin 1 (+V_{IN}).

Dimensions are in inches (mm)

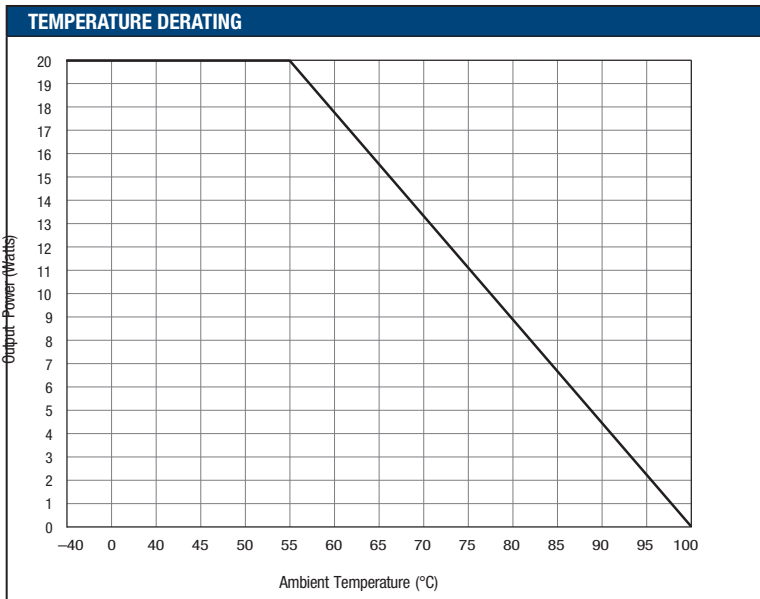

Performance/Functional Specifications

Typical @ T_A = +25°C under nominal line voltage and "full-load" conditions, unless noted. ①

Input	
Input Voltage Range:	
D12A Models	9-36 Volts (24V nominal)
D48A Models	18-75 Volts (48V nominal)
Input Current	See Ordering Guide
Input Filter Type ②	Pi
Overvoltage Shutdown:	
D12A Models	40 Volts
D48A Models	80 Volts
Reverse-Polarity Protection	Yes (Instantaneous, 6A maximum)
On/Off (Sync.) Control (Pin 4) ③	TTL high = off, low (or open) = on
Output	
Total Output Power	20W max., sum of all outputs
V _{OUT} Accuracy (50% loads):	
+5V Output	±1%
±12V or ±15V Outputs	±3%
Temperature Coefficient	±0.02% per °C
Ripple/Noise (20MHz BW) ②	See Ordering Guide
Line/Load Regulation	See Ordering Guide
Efficiency	See Ordering Guide
Isolation Voltage ④	1500Vdc, minimum
Isolation Capacitance	500pF
Current Limiting	Power down to restart
Short Circuit Protection at 25°C	5 min. max, 5V output 30 sec max. 12/15V outputs
Overvoltage Protection	Zener/transorb clamps, magnetic feedback
Dynamic Characteristics	
Transient Response (50% load step)	300µsec max. to ±2% of final value
Switching Frequency	165kHz (±15kHz)
Environmental	
Operating Temperature (ambient):	
Without Derating	-40 to +55°C
With Derating	to +100°C (See Derating Curve)
Storage Temperature	-40 to +105°C
Physical	
Dimensions	2" x 2" x 0.45" (51 x 51 x 11.4mm)
Shielding	5-sided
Case Connections:	
D12A Models	Pin 2 (-V _{IN})
D48A Models	Pin 1 (+V _{IN})
Case Material	Corrosion resistant steel with non-conductive, epoxy-based, black enamel finish and plastic baseplate
Pin Material	Copper alloy with gold plate over nickel underplate
Weight	2.7 ounces (77 grams)

① These converters require 10% min. loading on their primary output and 20% min. loading on their auxiliary outputs to maintain specified regulation. Operation under no-load conditions will not damage the devices; however they may not meet all listed specifications. For testing and specification purposes, "full load" is defined as 2.75A on the primary +5V output and ±250/200mA on the auxiliary ±12/15V outputs. This corresponds to a total output power of 19.75W.

② Application-specific internal input/output filtering can be recommended or perhaps added internally upon request. Contact MPS Applications Engineering for details.

③ Applying a voltage to the Control pin when no input power is applied to the converter can cause permanent damage to the converter.

④ D48A models have BASIC, D12A models have Functional insulation. Devices can be screened or modified for higher guaranteed isolation voltages. Contact MPS Applications Engineering for details.

⑤ To avoid damage to the surface finish, please do not use certain cleaning agents such as Vigon. Contact Murata Power Solutions for information.

Absolute Maximum Ratings

Input Voltage:	
"D12" Models	44 Volts
"D48" Models	88 Volts
Input Reverse-Polarity Protection	Current must be <6A. Brief duration only. Fusing recommended.
Output Overvoltage Protection	
+5V Output	6.8 Volts, limited duration
±12V Outputs	±15 Volts, limited duration
±15V Outputs	±18 Volts, limited duration
Output Current	Current limited. Max. currents are model dependent.
Storage Temperature	-40 to +105°C
Lead Temperature (soldering, 10 sec.)	+300°C

These are stress ratings. Exposure of devices to any of these conditions may adversely affect long-term reliability. Proper operation under conditions other than those listed in the Performance/Functional Specifications Table is not implied.

Technical Notes

Filtering and Noise Reduction

All A-Series TWR 20 Watt DC/DC Converters achieve their rated ripple and noise specifications without the use of external input/output capacitors. In critical applications, input/output noise may be further reduced by installing electrolytic capacitors across the input terminals and/or low-ESR tantalum or electrolytic capacitors across the output terminals. Output capacitors should be connected between their respective output pin (pin 5, 6 or 8) and Common (pin 7). The caps should be located as close to the power converters as possible. Typical values are listed below. In many applications, using values greater than those listed will yield better results.

To Reduce Input Ripple

D12A Models	20µF, 50V
D48A Models	10µF, 100V

To Reduce Output Ripple

+5V Output	47µF, 10V, Low ESR
±12/15V Outputs	33µF, 20V, Low ESR

In critical, space-sensitive applications, MPS may be able to tailor the internal input/output filtering of these units to meet your specific requirements. Contact our Applications Engineering Group for additional details.

Input Fusing

Certain applications and/or safety agencies may require the installation of fuses at the inputs of power conversion components. For MPS A-Series TWR 20 Watt DC/DC Converters, you should use slow-blow type fuses with values no greater than 4A for "D12A" models and 2A for "D48A" models.

On/Off Control

The On/Off Control pin (pin 4) may be used for remote on/off operation. A TTL logic high (+2 to +5 Volts, 250µA max.) applied to pin 4 disables the converter. A TTL logic low (0 to +0.8 Volts, 70µA max.), or no connection, enables the converter. Control voltages should be referenced to pin 2 (-Input). Applying a voltage to the Control pin when no input power is applied to the converter can cause permanent damage to the converter.

Typical Performance Curves (T_A = +25°C)

The performance curves below were derived from actual test data for a single model number (TWR-5/3000-12/250-D48). Since all devices in this series have the same circuit architecture, the performance curves are representative for all devices.

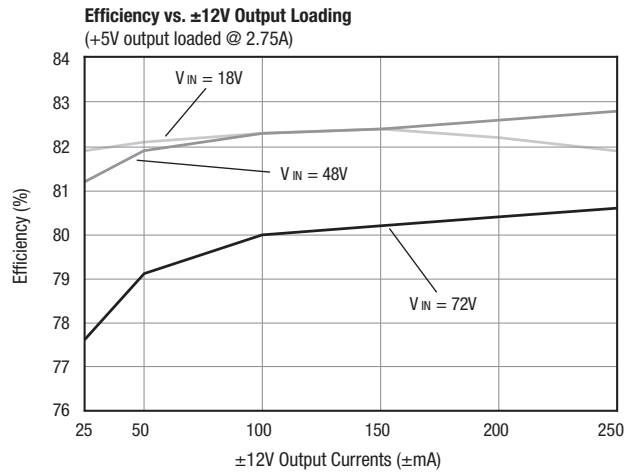
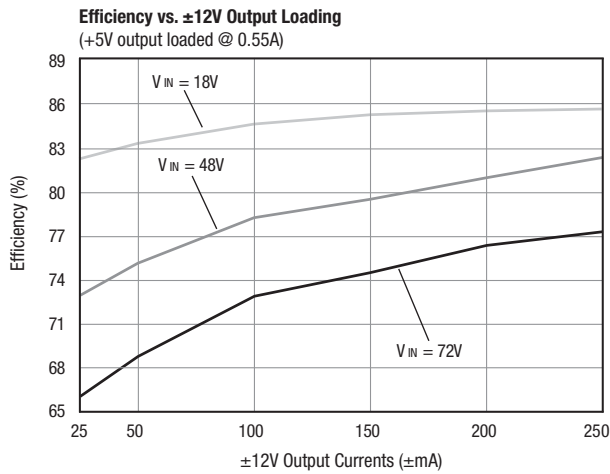
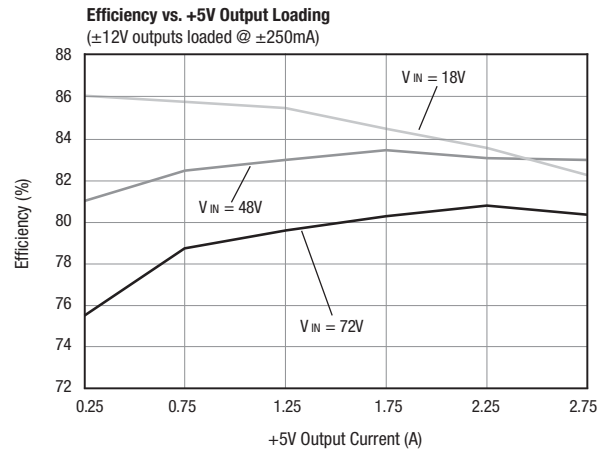
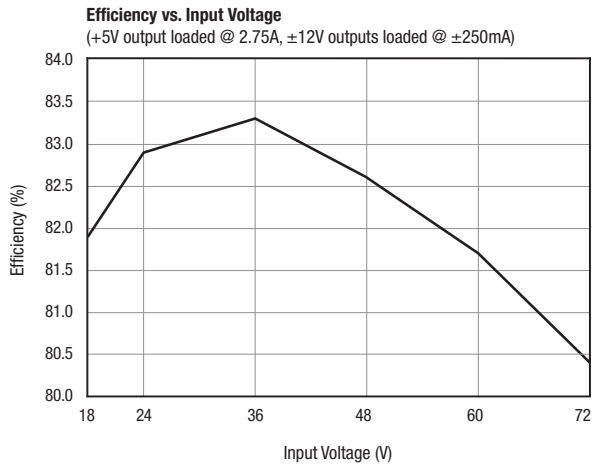

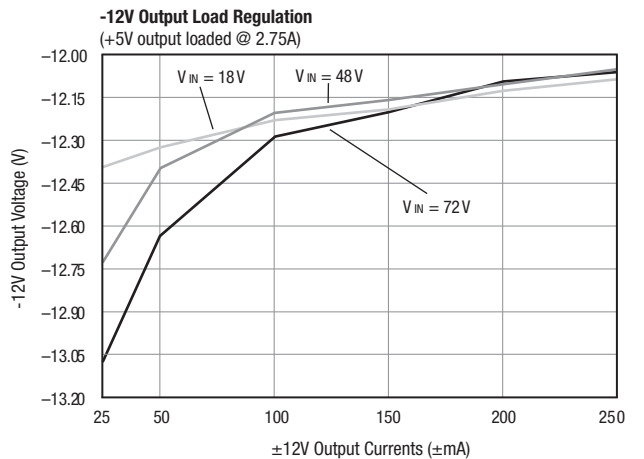
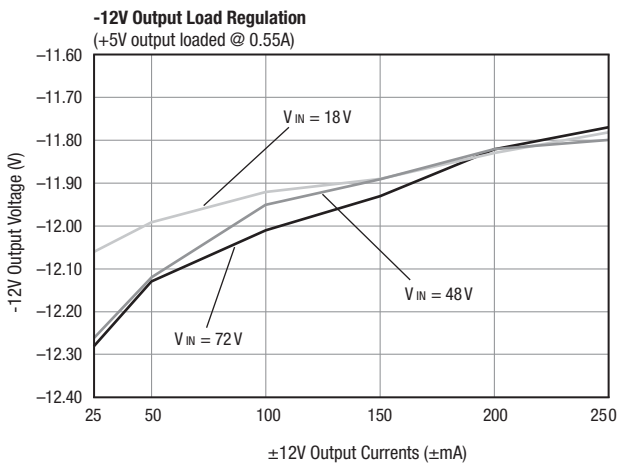
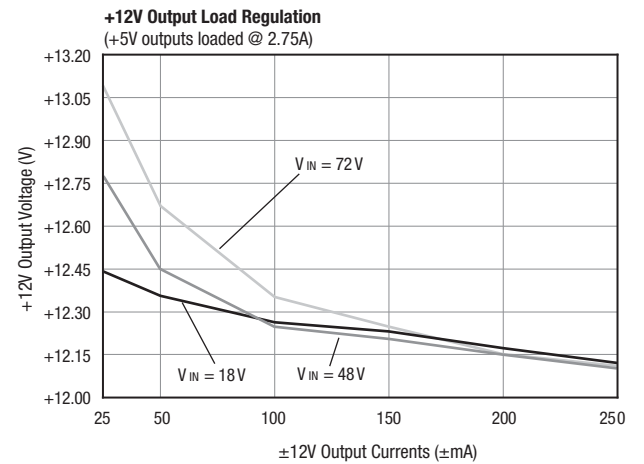
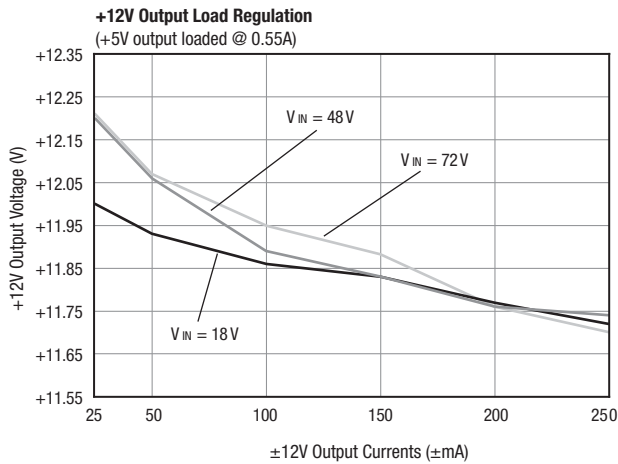
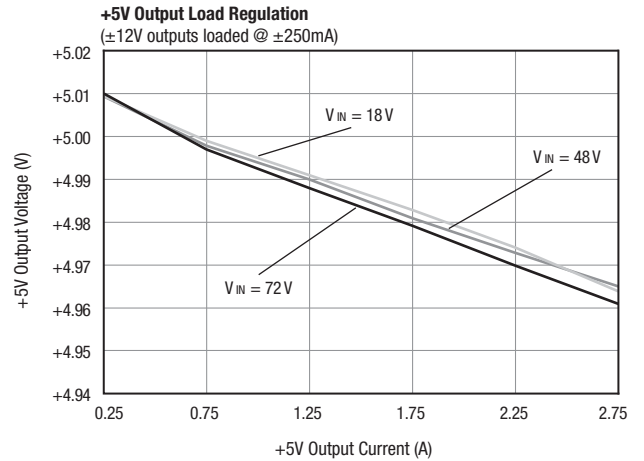
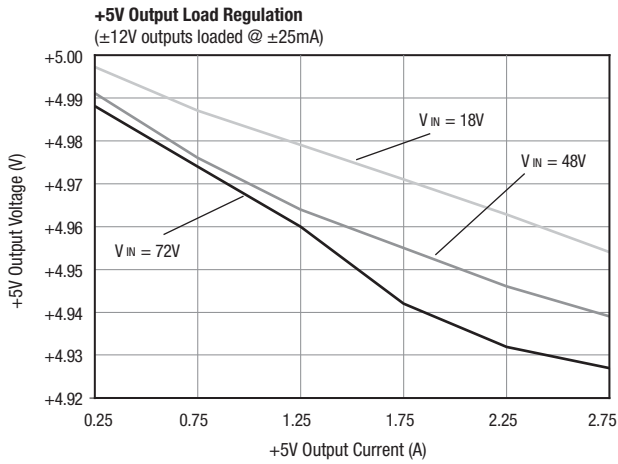

LINE REGULATION

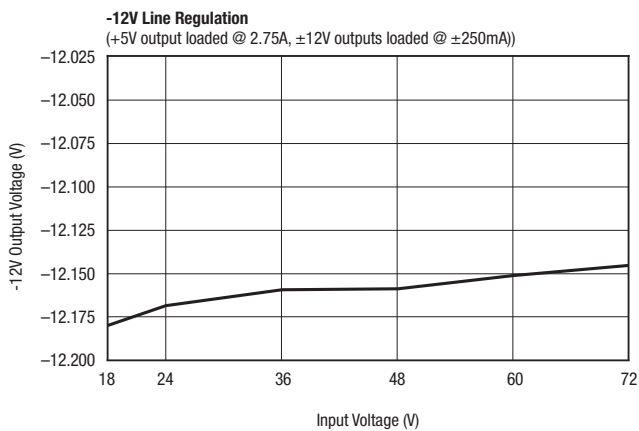
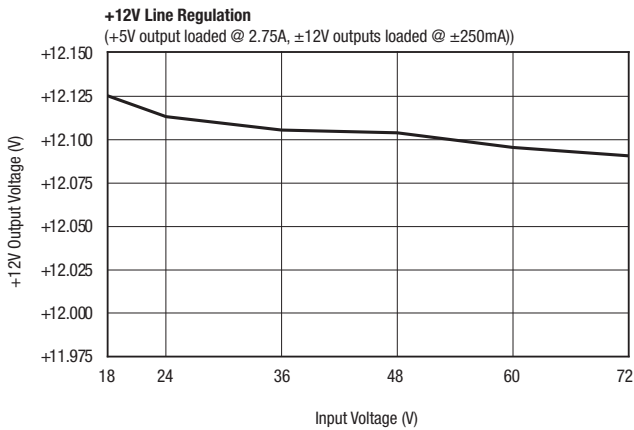
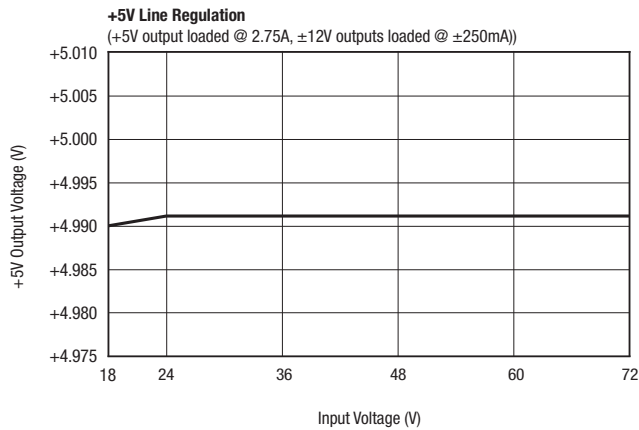

EMI RADIATED EMISSIONS

If you're designing with EMC in mind, note that all of MPS's TWR 20 Watt A-Series DC/DC Converters have been characterized for radiated and conducted emissions in our new EMI/EMC laboratory. Testing is conducted in an EMCO 5305 GTEM test cell utilizing EMCO automated EMC test software. Radiated emissions are tested to the limits of FCC Part 15, Class B and CISPR 22 (EN 55022) Class B. Correlation to other specifications can be supplied upon request. Radiated emissions plots to FCC and CISPR 22 for model TWR-5/3000-15/500-D12A appear below. Its performance is typical of all models in the Series. Published EMC test reports are available for each model number. Contact MPS's Applications Engineering for details.

TWR-5/3000-15/500-D12A Radiated Emissions
FCC Part 15 Class B, 3 Meters
Converter Output = +5Vdc @ 2.7A and ±15Vdc @ ±450mA

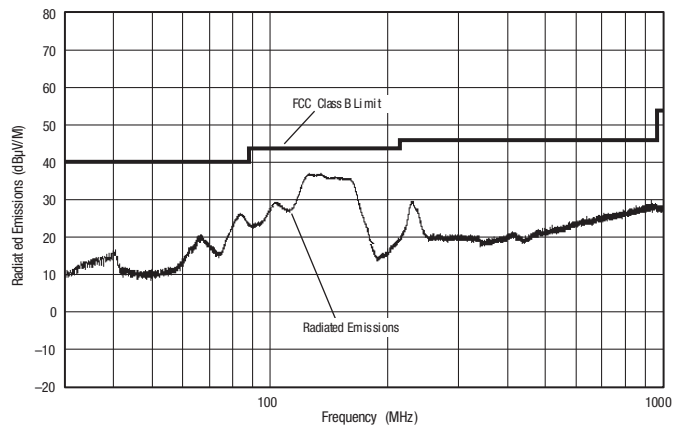

TWR-5/3000-15/500-D12A Radiated Emissions
EN 55022 Class B, 10 Meters
Converter Output = +5Vdc @ 2.7A and ±15Vdc @ ±450mA

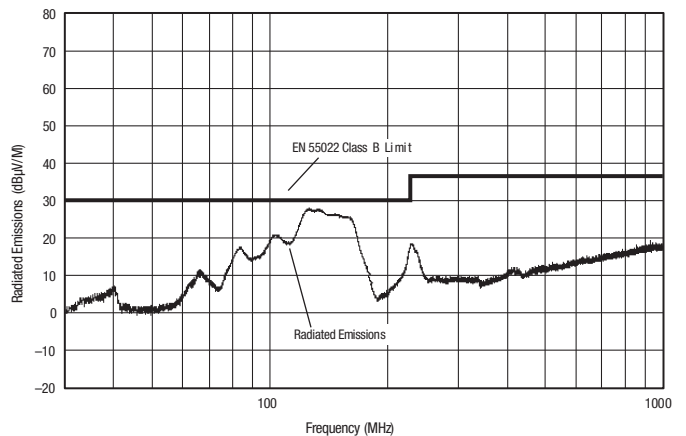

Quality and Reliability

The A-Series are the first DC/DC Converters to emerge from MPS's new, company-wide approach to designing and manufacturing the most reliable power converters available. The five-pronged program draws our Quality Assurance function into all aspects of new-product design, development, characterization, qualification and manufacturing.

Design for Reliability

Design for Reliability is woven throughout our multi-phased, new-product-development process. Design-for-reliability practices are fully documented and begin early in the new-product development cycle with the following goals:

1. To work from an approved components/vendors list ensuring the use of reliable components and the rigorous qualification of new components.
2. To design with safety margins by adhering to a strict set of derating guidelines and performing theoretical worst-case analyses.
3. To locate potential design weaknesses early in the product-development cycle by using extensive HALT (Highly Accelerated Life Testing).
4. To prove that early design improvements are effective by employing a thorough FRACA (Failure Reporting Analysis and Corrective Action) system.

HALT Testing

The goal of the accelerated-stress techniques used by MPS is to force device maturity, in a short period of time, by exposing devices to excessive levels of "every stimulus of potential value." We use HALT (Highly Accelerated Life Testing) repeatedly during the design and early manufacturing phases to detect potential electrical and mechanical design weaknesses that could result in possible future field failures.

During HALT, prototype and pre-production DC/DC converters are subjected to progressively higher stress levels induced by thermal cycling, rate of temperature change, vibration, power cycling, product-specific stresses (such as dc voltage variation) and combined environments. The stresses are not meant to simulate field environments but to expose any weaknesses in a product's electro/mechanical design and/or assembly processes. The goal of HALT is to make products fail so that device weaknesses can be analyzed and strengthened as appropriate. Applied

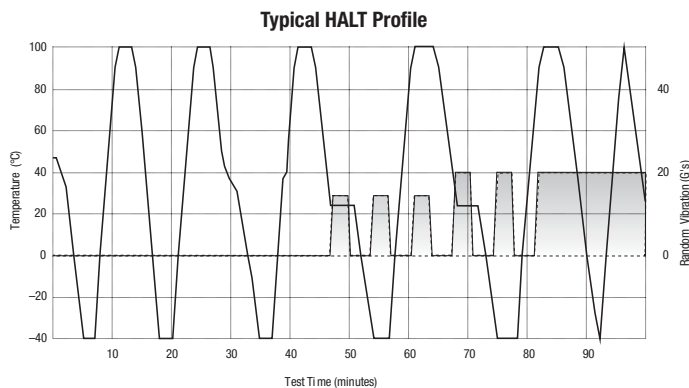

stresses are continually stepped up until products eventually fail. After corrective actions and/or design changes, stresses are stepped up again and the cycle is repeated until the "fundamental limit of the technology" is determined.

MPS has invested in a Qualmark OVS-1 HALT tester capable of applying voltage and temperature extremes as well as 6-axis, linear and rotational, random vibration. A typical HALT profile (shown above) consists of thermal cycling (-55 to +125°C, 30°C/minute) and simultaneous, gradually increasing, random longitudinal and rotational vibration up to 20G's with load cycling and applied-voltage extremes added as desired. Many devices in MPS's A-Series could not be made to fail prior to reaching either the limits of the HALT chamber or some previously known physical limit of the device. We also use the HALT chamber and its ability to rapidly cool devices to verify their "cold-start" capabilities.

Qualification

For each new product, electrical performance is verified via a comprehensive characterization process and long-term reliability is confirmed via a rigorous qualification procedure. The qual procedure includes such strenuous tests as thermal shock and 500 hour life. Qual testing is summarized below.

Qualification Testing

Qualification Test	Method/Comments
HALT	MPS in-house procedure
High Temperature Storage	Max. rated temp., 1,000 hours
Thermal Shock	10 cycles, -55 to +125°C
Temperature/Humidity	+85°C, 85% humidity, 48 hours
Lead Integrity	MPS in-house procedure
Life Test	+70°C, 500 hours*
Marking Permanency	MPS in-house procedure
End Point Electrical Tests	Per product specification

* Interim electrical test at 200 hours.

In-Line Process Controls and Screening

A combination of statistical sampling and 100% inspection techniques keeps our assembly line under constant control. Parameters such as solder-paste thickness, component placement, cleanliness, etc. are statistically sampled, charted and fine tuned as necessary. Visual inspections are performed by trained operators after pick-and-place, soldering and cleaning operations. Units are 100% electrically tested prior to potting. All devices are temperature cycled, burned-in, hi-pot tested and final-electrical tested prior to external visual examination, packing and shipping.

Rapid Response to Problems

MPS employs an outstanding corrective-action system to immediately address any detected shortcomings in either products or processes. Whenever our assembly, quality or engineering personnel spot a product/process problem, or if a product is returned with a potential defect, we immediately perform a detailed failure analysis and, if necessary, undertake corrective actions. Over time, this system has helped refine our assembly operation to yield one of the lowest product defect rates in the industry.

20 Watt Converter Operational Details

There are several operational details of the 20W TWR series to be aware of when applying these converters.

20 Watts maximum power

The total maximum power for all outputs is 20 Watts. This is the sum of each separate output. Any one output may achieve its maximum power as long as the sum of all outputs for the whole converter does not exceed 20 Watts.

For example, using model TWR-5/3000-15/500-D12A, if the maximum power is drawn from the two ± 15 Volt supplies, this produces 15 Watts (7.5 W plus 7.5 W) total power. The 5V output may then deliver 5 Watts maximum (not 15W) so that the total converter power is $7.5W+7.5W+5W=20W$.

Regulation Differences Between Outputs

Looking at the Schematic diagram, observe that magnetic energy driven from the primary side affects all three outputs simultaneously since they share a common transformer in combination with magnetically coupled output inductor. We see that the regulation feedback is derived directly from the 5 Volt output and indirectly from the 12/15V outputs. Increasing current on the 12/15V outputs absorbs magnetic energy driving the 5V output therefore reducing the 5V output voltage. Regulation compensates for this drop in output voltage but not to the same extent as the 5V output regulation.

Short-circuit Conditions

Because of the interconnected regulation and common transformer, a short circuit on one output will cause a voltage reduction on the remaining unshorted outputs. This effect is more pronounced for the 5V superior output vs. the 12/15V subordinate outputs. That is, a 5V short essentially places the PWM controller in power-limit mode whereas a 12/15V short may leave some partial power available on the remaining outputs.

Time limits on short circuits

The 5V output will tolerate 5 minutes maximum short circuit time at +25 deg.C. For the 12/15V outputs, short circuits must limit to 30 seconds at +25 deg.C. Failure to remove the short circuits within these time limits may damage the converter or cause permanent operational changes. Higher ambient temperatures require reduced short circuit times. As long as shorts or overcurrents are removed within these time limits, the outputs will automatically recover to normal operation.

As a practical matter, since it is difficult to control short circuit duration, make sure that the application is highly unlikely to cause a short circuit or the input is disconnected by means of a circuit breaker or fuse.

The Three Outputs are not isolated from each other

The three outputs share a common ground return which is fully isolated from the primary input side but not between each other. Therefore do not apply the outputs to applications which require isolation between the 5V and 12/15V sections.

