

Part No. M620720

ISM 868 & 915 MHz Embedded Ceramic Antenna

868 MHz; 915 MHz

Supports: Tracking, Smart Home, Agriculture, Automotive, Healthcare, Digital Signage, Wearables, Industrial Devices

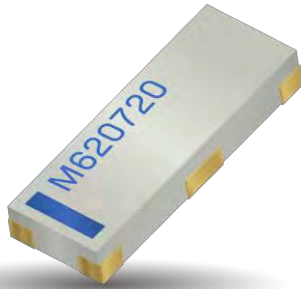

ISM 868 & 915 MHz Embedded Ceramic Antenna

868 MHz; 915 MHz

KEY BENEFITS

Stay-in-Tune

IMD antenna technology provides superior RF field containment, resulting in less interaction with surrounding components.

Quicker Time-to-Market

By optimizing antenna size, performance and emissions, customer and regulatory specifications are more easily met.

Reliability

Products are the latest RoHS version compliant.

APPLICATIONS

- Embedded design
- Cellular, Headsets, Tablets
- Gateway, Access Point
- Handheld
- Telematics
- Tracking
- Healthcare
- M2M, Industrial devices
- Smart Grid
- OBD-II

KYOCERA AVX's series of Ceramic Isolated Magnetic Dipole™ (IMD) antennas deliver on the key needs of device designers for higher functionality and performance in smaller/thinner designs. These innovative antennas provide compelling advantages for 868 and 915 MHz ISM enabled handheld devices, media players and other mobile devices.

Real-World Performance and Implementation

Ceramic antennas may look alike on the outside, but the important difference is inside. Other antennas may contain simple PIFA or monopole designs that interact with their surroundings, complicating layout or changing performance with use position. KYOCERA AVX's antennas utilize patented IMD technology to deliver a unique size and performance combination.

Electrical Specifications

Typical performance on 40 x 100 mm PCB

Frequency	863 - 870 MHz	902 - 928 MHz
Peak Gain	0.30 dBi	0.75 dBi
Average Efficiency	58%	60%
VSWR Match	1.6:1 max	2.5:1 max
Feed Point Impedance	50 ohms	
Polarization	Linear	
Power Handling	0.5 Watt CW	

Mechanical Specifications & Ordering Part Number

Ordering Part Number	M620720
Size (mm)	6.00 x 2.00 x 1.08
Mounting	SMT
Weight (grams)	0.1
Packaging	Tape & Reel, M620720 – 1,000 pieces per reel
Demo Board	M620720-01

ISM 868 & 915 MHz Embedded Ceramic Antenna Specifications
 KYOCERA AVX produces a wide variety of standard and custom antennas to meet user needs.

Antenna Dimensions

Typical antenna dimensions (mm)

Part Number	A (mm)	B (mm)	C (mm)
M620720	6.00 ± 0.2	2.00 ± 0.2	1.08 ± 0.1

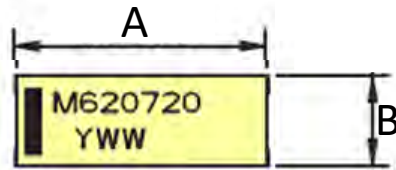

Top View



Height

Pin	Description
1	Feed
2	Dummy
3	Ground

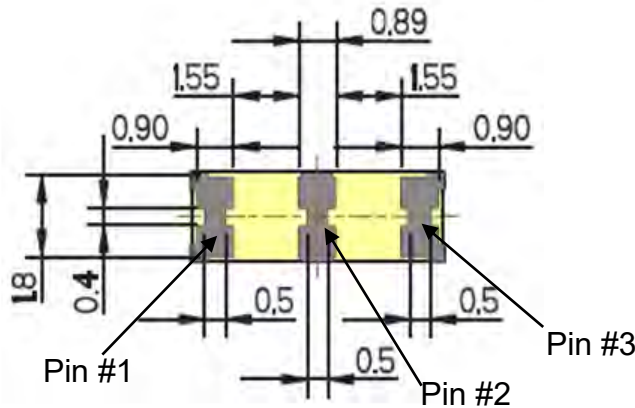

Bottom View

ISM 868 & 915 MHz Embedded Ceramic Antenna Specifications
 KYOCERA AVX produces a wide variety of standard and custom antennas to meet user needs.

VSWR, Efficiency Plots (Tuned @ 868 MHz)

Typical performance on 40 x 100 mm PCB

Component	863-870 MHz	
	Value	Tolerance
P1	5.0 pF	±0.05 pF
P2	82 pF ± 5%	

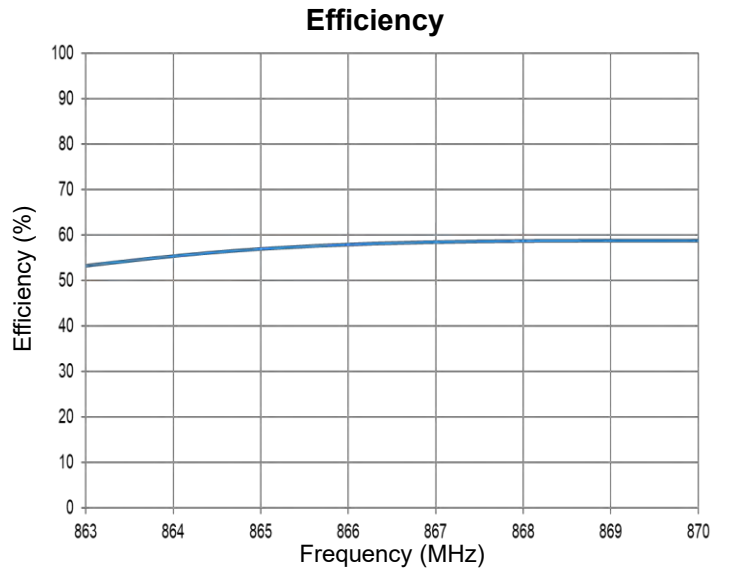
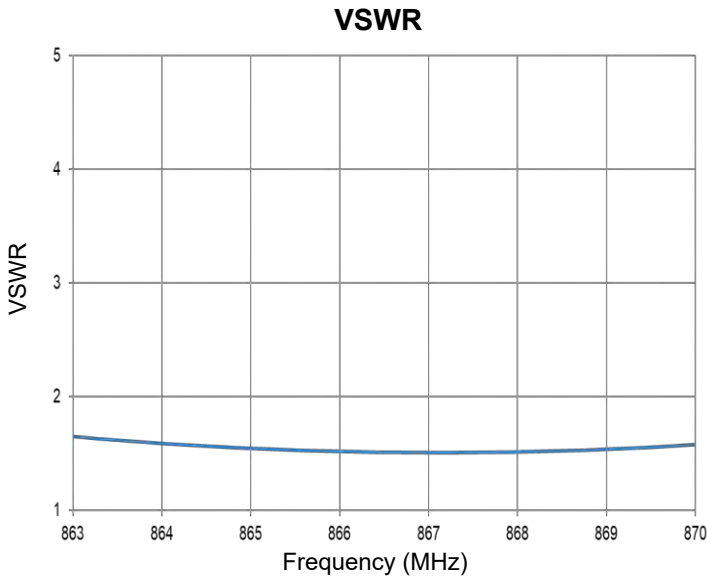
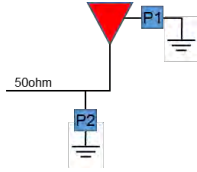

Antenna Radiation Patterns

Typical performance on 40 x 100 mm PCB
 Measured @ 868 MHz

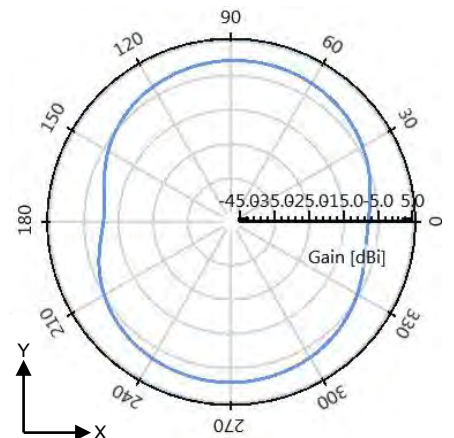
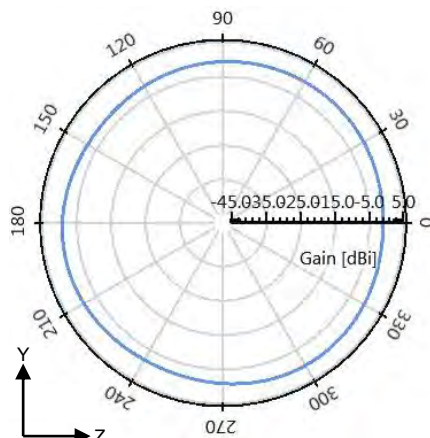
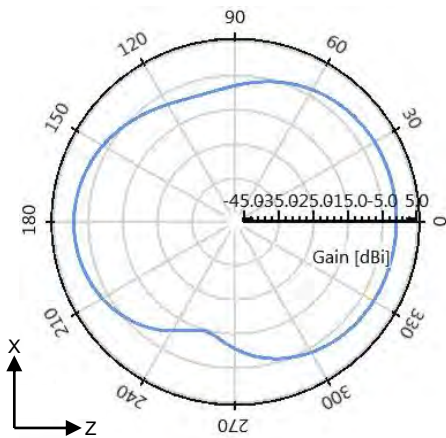
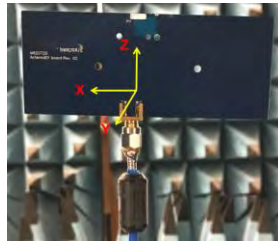

ISM 868 & 915 MHz Embedded Ceramic Antenna Specifications
 KYOCERA AVX produces a wide variety of standard and custom antennas to meet user needs.

VSWR, Efficiency Plots (Tuned @ 915 MHz)

Typical performance on 40 x 100 mm PCB

Component	902-928 MHz	
	Value	Tolerance
P1	3.6 pF	±0.05 pF
P2	82 pF ± 5%	

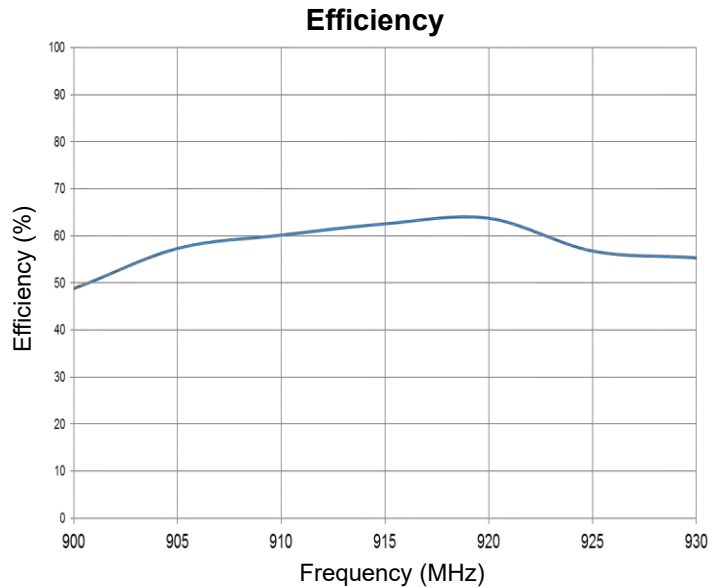
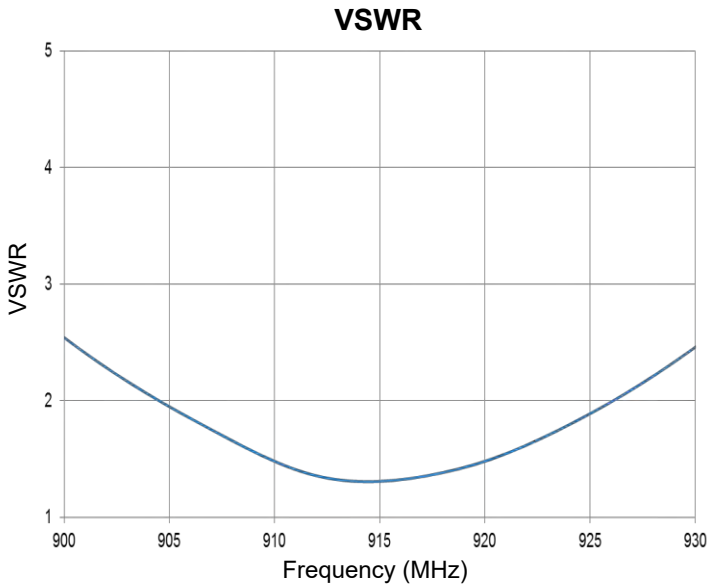
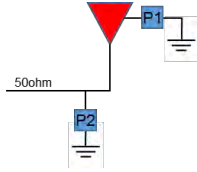

Antenna Radiation Patterns

Typical performance on 40 x 100 mm PCB
 Measured @ 915 MHz

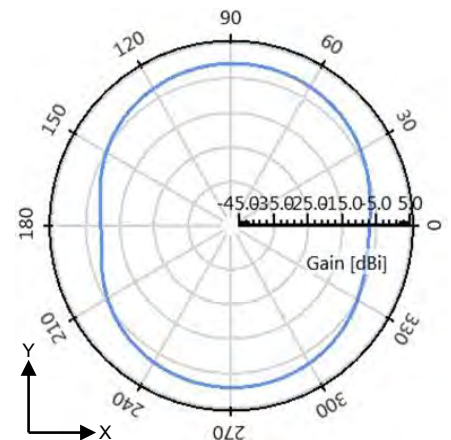
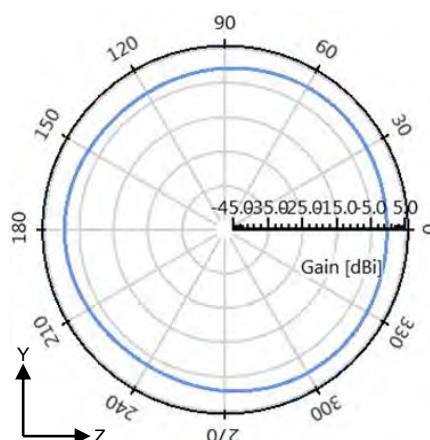
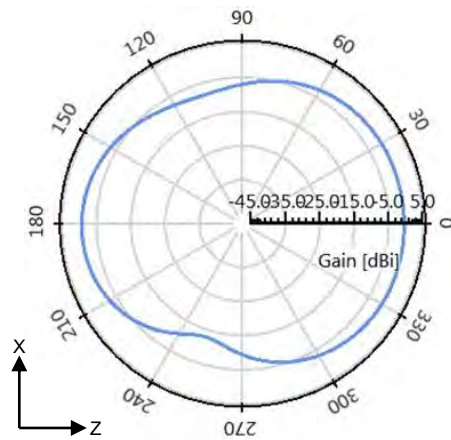
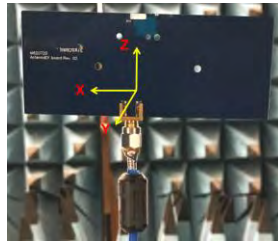

ISM 868 & 915 MHz Embedded Ceramic Antenna Specifications
 KYOCERA AVX produces a wide variety of standard and custom antennas to meet user needs.

Antenna Layout

Typical layout dimensions (mm)

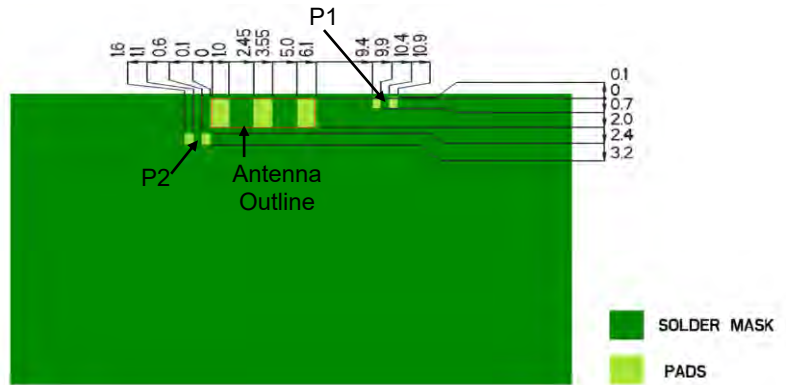
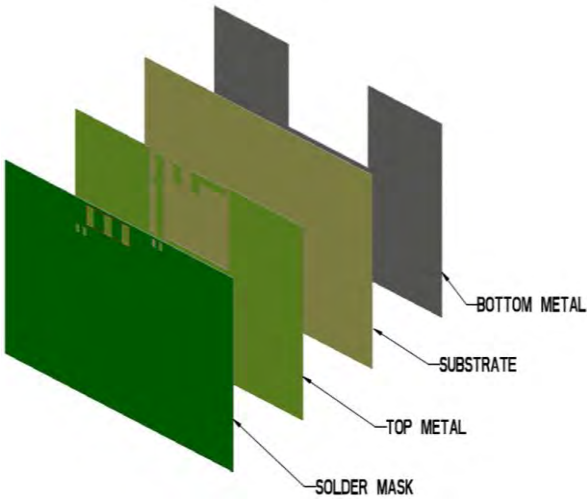

- Additional VIAS: Diam. 0.2mm to be placed around antenna, (no vias on transmission lines).
- Via holes must be covered by solder mask

Pin Descriptions

Pin#	Description
1	Feed
2	Dummy
3	Ground

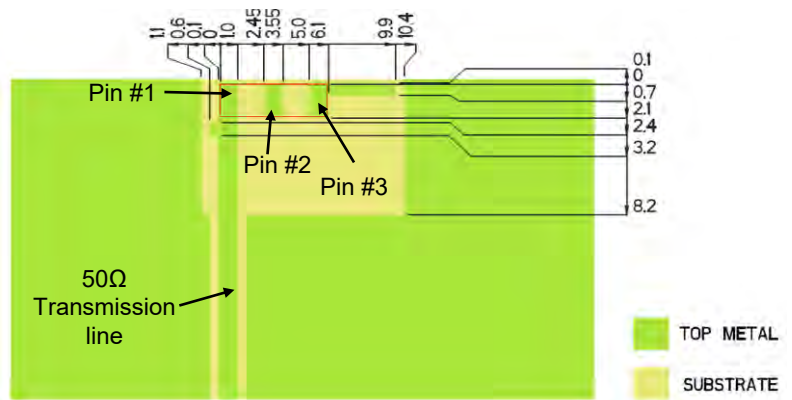

Matching Network (Demo Board)

Component	863-870 MHz		902-928 MHz	
	Value	Tolerance	Value	Tolerance
P1	5.0 pF	±0.05 pF	3.6 pF	±0.05 pF
P2	82 pF ± 5%			

*Actual matching values depend on customer design

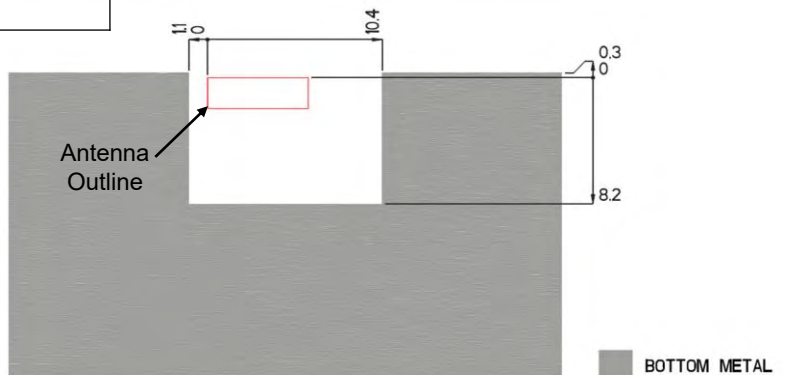
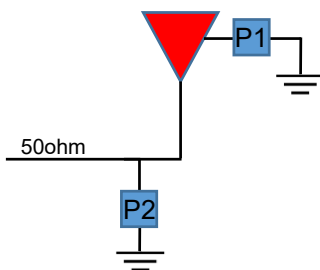

ISM 868 & 915 MHz Embedded Ceramic Antenna Specifications
 KYOCERA AVX produces a wide variety of standard and custom antennas to meet user needs.

Antenna Layout Tips (General reference)

Important, layout guidelines for correct operation of KYOCERA AVX Ceramic Antennas. Please read guidelines below before laying out the antenna in a device. Figure 1 shows the typical antenna layout. Figure 2 shows KYOCERA AVX's antenna layout.

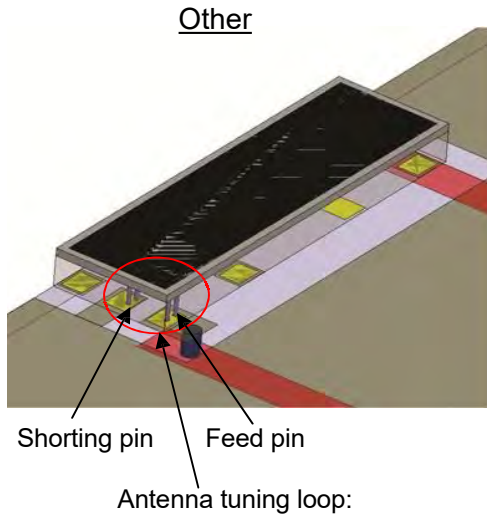

Figure 1
 Typical Antenna Layout

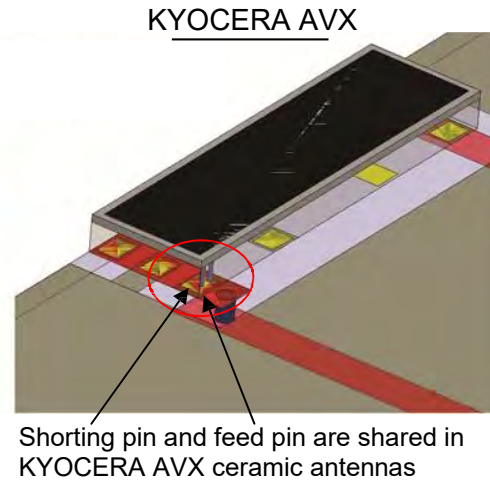

Figure 2
 KYOCERA AVX Antenna
 Layout (Required)

- The antenna tuning loop is formed by the PCB layout.
- The feed pin and shorting pin are combined because it requires very close proximity to achieve more band-width.

ISM 868 & 915 MHz Embedded Ceramic Antenna Specifications
 KYOCERA AVX produces a wide variety of standard and custom antennas to meet user needs.

Antenna Demo Board

Typical layout dimensions (mm)

Part Number	A (mm)	B (mm)	C (mm)
M620720-01	100.0	40.0	50.0

