

**SMPS MOSFET IRF3703PbF**

HEXFET® Power MOSFET

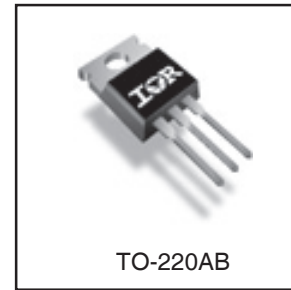
**Applications**

- Synchronous Rectification
- Active ORing
- Lead-Free

$V_{DSS}$	$R_{DS(on) \max}$	$I_D$
30V	2.8mΩ	210A <sup>⑥</sup>

**Benefits**

- Ultra Low On-Resistance
- Low Gate Impedance to Reduce Switching Losses
- Fully Avalanche Rated



**Absolute Maximum Ratings**

	Parameter	Max.	Units
$I_D @ T_C = 25^\circ\text{C}$	Continuous Drain Current, $V_{GS} @ 10\text{V}$	210 <sup>⑥</sup>	A
$I_D @ T_C = 100^\circ\text{C}$	Continuous Drain Current, $V_{GS} @ 10\text{V}$	100 <sup>⑥</sup>	
$I_{DM}$	Pulsed Drain Current <sup>①</sup>	1000	
$P_D @ T_C = 25^\circ\text{C}$	Power Dissipation	230	W
$P_D @ T_A = 25^\circ\text{C}$	Power Dissipation	3.8	
	Linear Derating Factor	1.5	W/°C
$V_{GS}$	Gate-to-Source Voltage	$\pm 20$	V
dv/dt	Peak Diode Recovery dv/dt <sup>③</sup>	5.0	V/ns
$T_J, T_{STG}$	Junction and Storage Temperature Range	-55 to + 175	°C

**Thermal Resistance**

	Parameter	Typ.	Max.	Units
$R_{\theta JC}$	Junction-to-Case	—	0.65	°C/W
$R_{\theta CS}$	Case-to-Sink, Flat, Greased Surface	0.5	—	
$R_{\theta JA}$	Junction-to-Ambient	—	62	

Notes <sup>①</sup> through <sup>⑥</sup> are on page 8  
www.irf.com

# IRF3703PbF

International  
**IR** Rectifier

## Static @ $T_J = 25^\circ\text{C}$ (unless otherwise specified)

	Parameter	Min.	Typ.	Max.	Units	Conditions
$V_{(BR)DSS}$	Drain-to-Source Breakdown Voltage	30	—	—	V	$V_{GS} = 0V, I_D = 250\mu A$
$\Delta V_{(BR)DSS}/\Delta T_J$	Breakdown Voltage Temp. Coefficient	—	0.028	—	V/°C	Reference to $25^\circ\text{C}, I_D = 1\text{mA}$
$R_{DS(on)}$	Static Drain-to-Source On-Resistance	—	2.3	2.8	m $\Omega$	$V_{GS} = 10V, I_D = 76A$ ④
		—	2.8	3.9		$V_{GS} = 7.0V, I_D = 76A$ ④
$V_{GS(th)}$	Gate Threshold Voltage	2.0	—	4.0	V	$V_{DS} = V_{GS}, I_D = 250\mu A$
$I_{DSS}$	Drain-to-Source Leakage Current	—	—	20	$\mu A$	$V_{DS} = 24V, V_{GS} = 0V$
		—	—	250		$V_{DS} = 24V, V_{GS} = 0V, T_J = 150^\circ\text{C}$
$I_{GSS}$	Gate-to-Source Forward Leakage	—	—	200	nA	$V_{GS} = 20V$
	Gate-to-Source Reverse Leakage	—	—	-200		$V_{GS} = -20V$

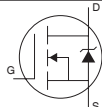
## Dynamic @ $T_J = 25^\circ\text{C}$ (unless otherwise specified)

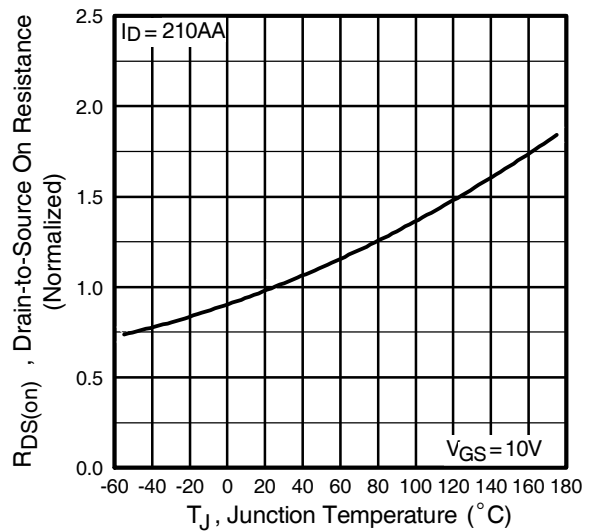
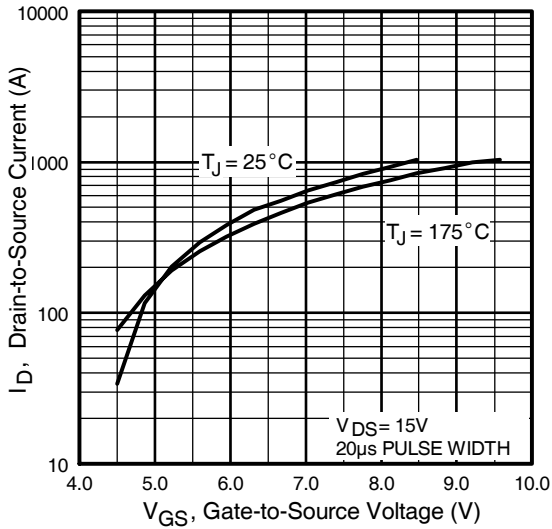
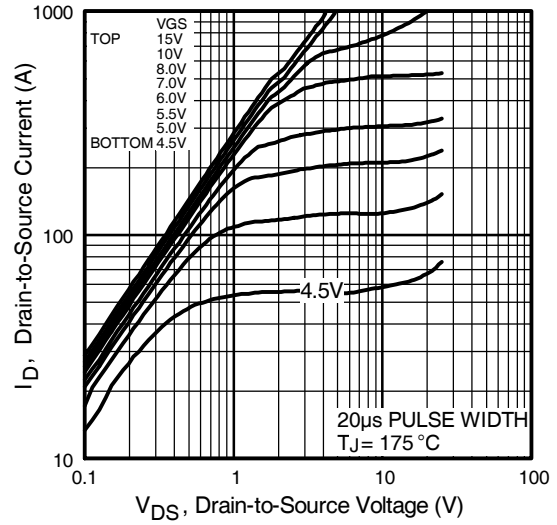
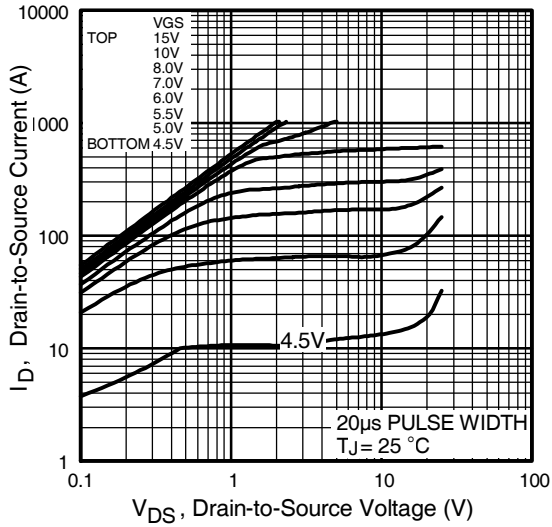
	Parameter	Min.	Typ.	Max.	Units	Conditions
$g_{fs}$	Forward Transconductance	150	—	—	S	$V_{DS} = 24V, I_D = 76A$
$Q_g$	Total Gate Charge	—	209	—	nC	$I_D = 76A$
$Q_{gs}$	Gate-to-Source Charge	—	62	—		$V_{DS} = 24V$
$Q_{gd}$	Gate-to-Drain ("Miller") Charge	—	42	—		$V_{GS} = 10V$ , ④
$t_{d(on)}$	Turn-On Delay Time	—	18	—	ns	$V_{DD} = 15V, V_{GS} = 10V$
$t_r$	Rise Time	—	123	—		$I_D = 76A$
$t_{d(off)}$	Turn-Off Delay Time	—	53	—		$R_G = 1.8\Omega$
$t_f$	Fall Time	—	24	—		$V_{GS} = 10V$ ④
$C_{iss}$	Input Capacitance	—	8250	—	pF	$V_{GS} = 0V$
$C_{oss}$	Output Capacitance	—	3000	—		$V_{DS} = 25V$
$C_{rss}$	Reverse Transfer Capacitance	—	290	—		$f = 1.0\text{MHz}$
$C_{oss}$	Output Capacitance	—	10360	—		$V_{GS} = 0V, V_{DS} = 1.0V, f = 1.0\text{MHz}$
$C_{oss}$	Output Capacitance	—	3060	—		$V_{GS} = 0V, V_{DS} = 24V, f = 1.0\text{MHz}$
$C_{oss \text{ eff.}}$	Effective Output Capacitance	—	2590	—		$V_{GS} = 0V, V_{DS} = 0V \text{ to } 24V$ ⑤

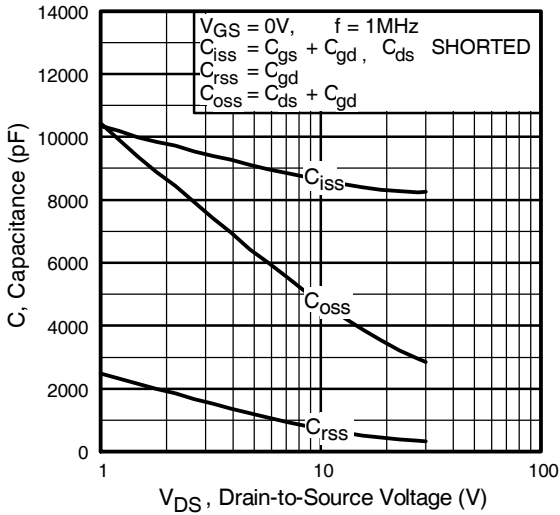
## Avalanche Characteristics

	Parameter	Typ.	Max.	Units
$E_{AS}$	Single Pulse Avalanche Energy②	—	1700	mJ
$I_{AR}$	Avalanche Current③	—	76	A
$E_{AR}$	Repetitive Avalanche Energy③	—	23	mJ

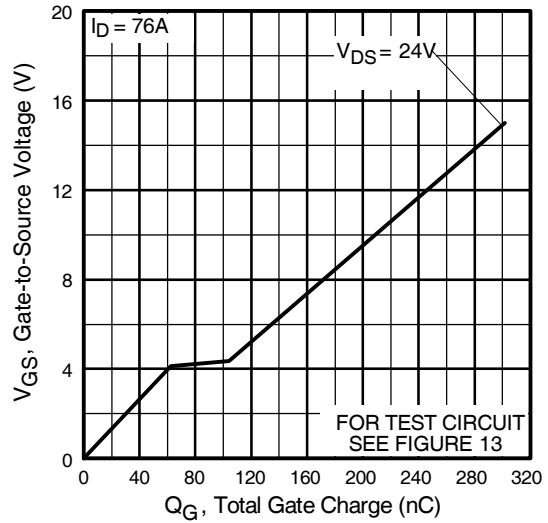
## Diode Characteristics

	Parameter	Min.	Typ.	Max.	Units	Conditions
$I_S$	Continuous Source Current (Body Diode)	—	—	210⑥	A	MOSFET symbol showing the integral reverse p-n junction diode. 
$I_{SM}$	Pulsed Source Current (Body Diode) ①	—	—	1000		
$V_{SD}$	Diode Forward Voltage	—	0.8	1.3	V	$T_J = 25^\circ\text{C}, I_S = 76A, V_{GS} = 0V$ ④
$t_{rr}$	Reverse Recovery Time	—	80	120	ns	$T_J = 25^\circ\text{C}, I_F = 76A, V_{DS} = 16V$
$Q_{rr}$	Reverse Recovery Charge	—	185	275	nC	$di/dt = 100A/\mu s$ ④

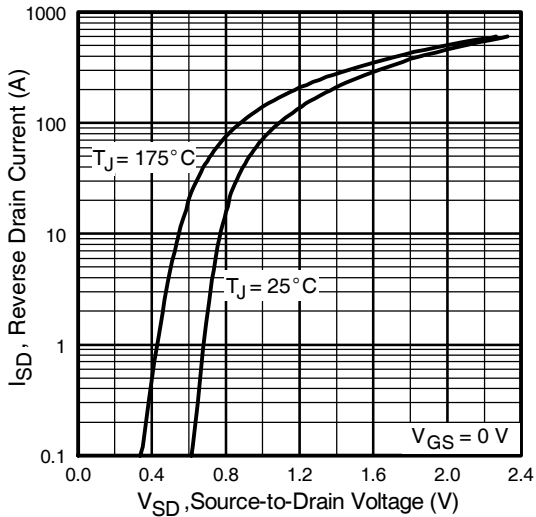




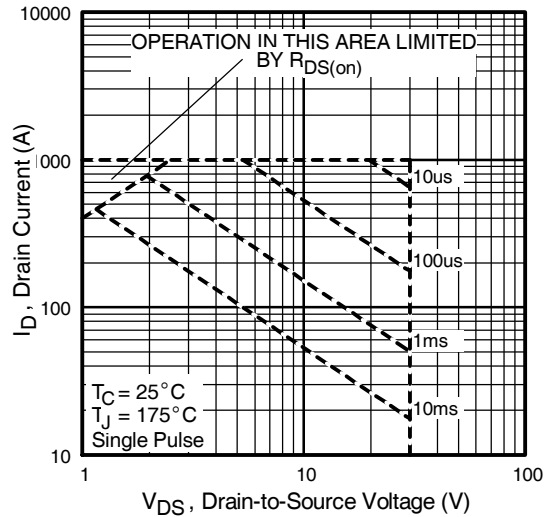
**Fig 5.** Typical Capacitance Vs. Drain-to-Source Voltage



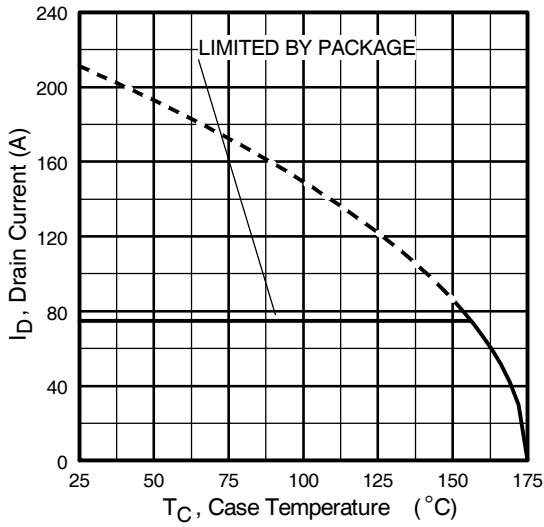
**Fig 6.** Typical Gate Charge Vs. Gate-to-Source Voltage



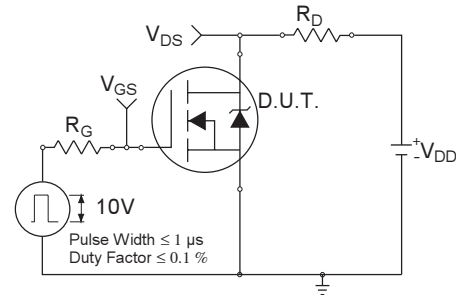
**Fig 7.** Typical Source-Drain Diode Forward Voltage



**Fig 8.** Maximum Safe Operating Area



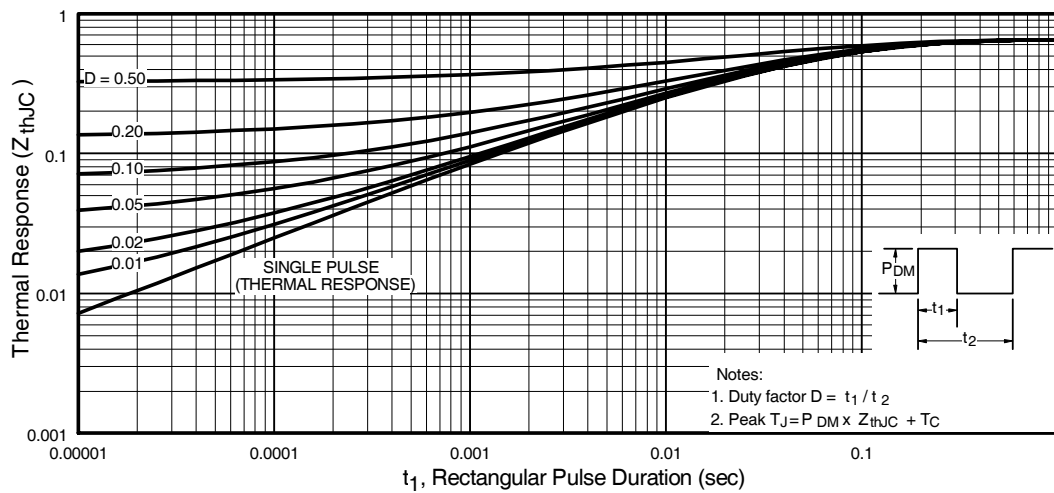
**Fig 9.** Maximum Drain Current Vs. Case Temperature



**Fig 10a.** Switching Time Test Circuit



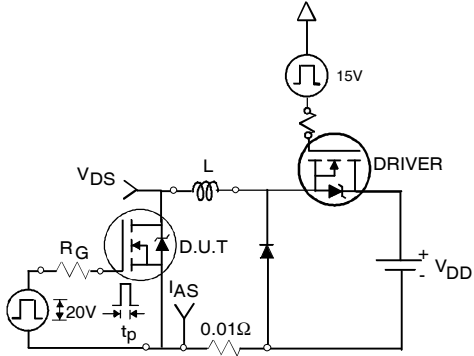
**Fig 10b.** Switching Time Waveforms



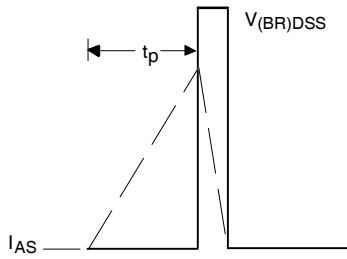
**Fig 11.** Maximum Effective Transient Thermal Impedance, Junction-to-Case

# IRF3703PbF

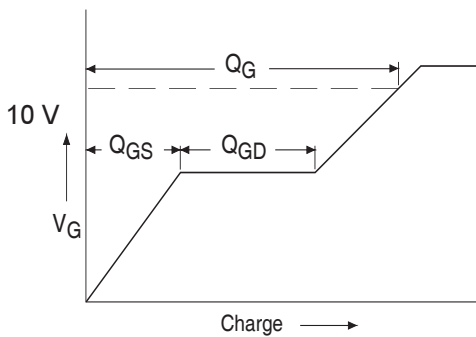
International  
**IR** Rectifier



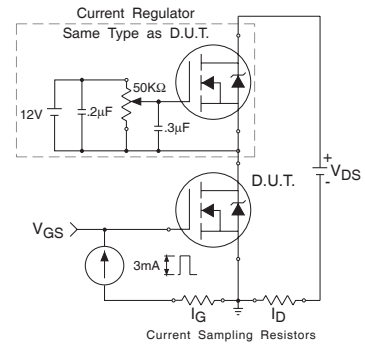
**Fig 12a.** Unclamped Inductive Test Circuit



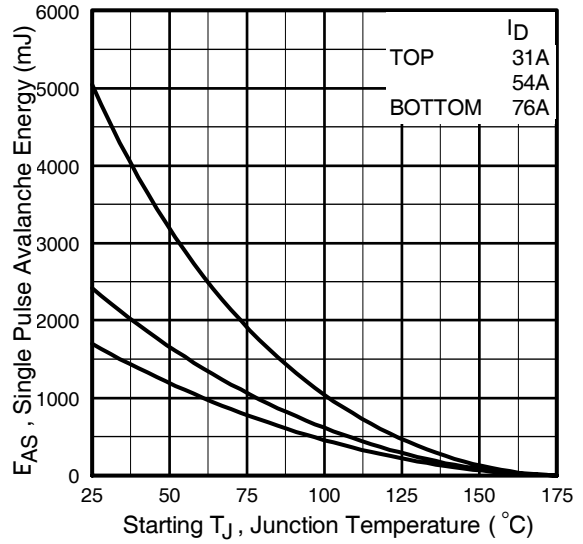
**Fig 12b.** Unclamped Inductive Waveforms



**Fig 13a.** Basic Gate Charge Waveform

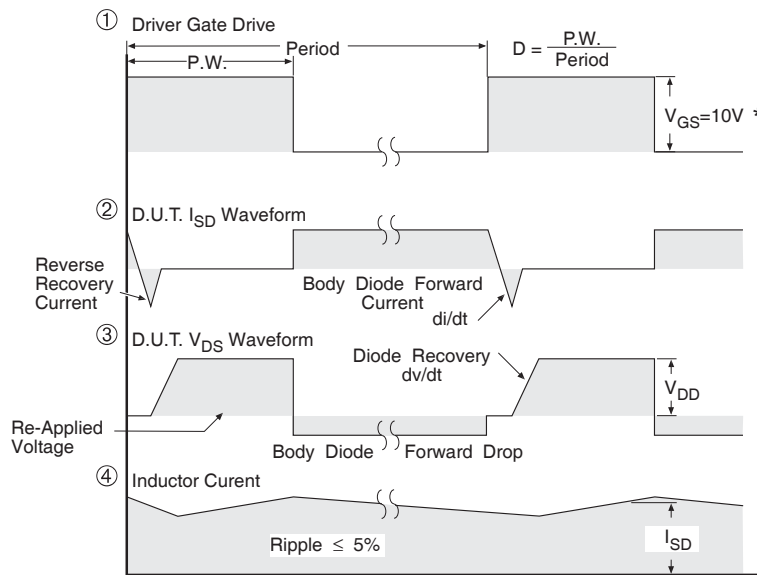


**Fig 13b.** Gate Charge Test Circuit



**Fig 12c.** Maximum Avalanche Energy Vs. Drain Current

**Peak Diode Recovery dv/dt Test Circuit**



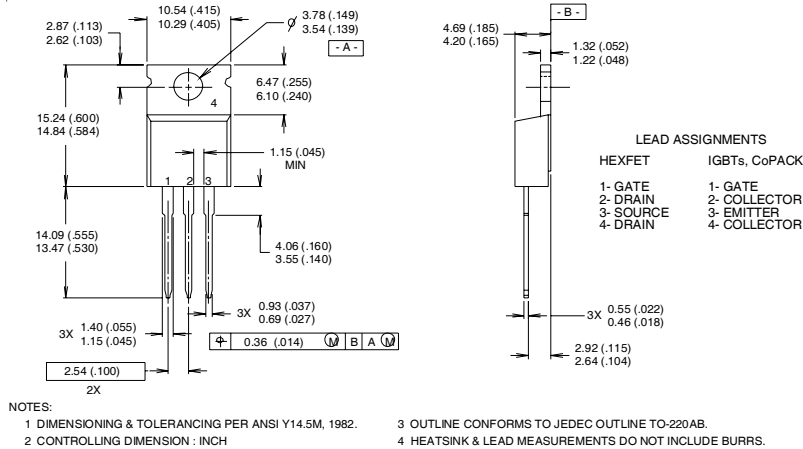
\*  $V_{GS} = 5V$  for Logic Level Devices

**Fig 14.** For N-Channel HEXFET<sup>®</sup> Power MOSFET

# IRF3703PbF

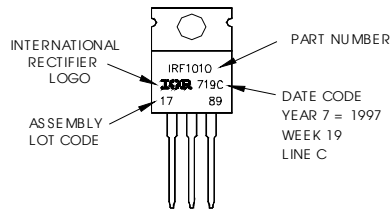
International  
**IR** Rectifier

## TO-220AB Package Outline



## TO-220AB Part Marking Information

EXAMPLE: THIS IS AN IRF1010  
 LOT CODE 1789  
 ASSEMBLED ON WW 19, 1997  
 IN THE ASSEMBLY LINE "C"  
**Note:** "P" in assembly line  
 position indicates "Lead-Free"



### Notes:

- ① Repetitive rating; pulse width limited by max. junction temperature.
- ② Starting  $T_J = 25^\circ\text{C}$ ,  $L = 0.6\text{mH}$   
 $R_G = 25\Omega$ ,  $I_{AS} = 76\text{A}$ .
- ③  $I_{SD} \leq 76\text{A}$ ,  $di/dt \leq 100\text{A}/\mu\text{s}$ ,  $V_{DD} \leq V_{(BR)DSS}$ ,  
 $T_J \leq 175^\circ\text{C}$
- ④ Pulse width  $\leq 300\mu\text{s}$ ; duty cycle  $\leq 2\%$ .
- ⑤  $C_{oss}$  eff. is a fixed capacitance that gives the same charging time as  $C_{oss}$  while  $V_{DS}$  is rising from 0 to 80%  $V_{DSS}$
- ⑥ Calculated continuous current based on maximum allowable junction temperature. Package limitation current is 75A

Data and specifications subject to change without notice.  
 This product has been designed and qualified for the industrial market.  
 Qualification Standards can be found on IR's Web site.

International  
**IR** Rectifier

**IR WORLD HEADQUARTERS:** 233 Kansas St., El Segundo, California 90245, USA Tel: (310) 252-7105  
 TAC Fax: (310) 252-7903  
 Visit us at [www.irf.com](http://www.irf.com) for sales contact information.02/04



Note: For the most current drawings please refer to the IR website at:  
<http://www.irf.com/package/>

## **IMPORTANT NOTICE**

The information given in this document shall in no event be regarded as a guarantee of conditions or characteristics ("Beschaffheitsgarantie").

With respect to any examples, hints or any typical values stated herein and/or any information regarding the application of the product, Infineon Technologies hereby disclaims any and all warranties and liabilities of any kind, including without limitation warranties of non-infringement of intellectual property rights of any third party.

In addition, any information given in this document is subject to customer's compliance with its obligations stated in this document and any applicable legal requirements, norms and standards concerning customer's products and any use of the product of Infineon Technologies in customer's applications.

The data contained in this document is exclusively intended for technically trained staff. It is the responsibility of customer's technical departments to evaluate the suitability of the product for the intended application and the completeness of the product information given in this document with respect to such application.

For further information on the product, technology, delivery terms and conditions and prices please contact your nearest Infineon Technologies office ([www.infineon.com](http://www.infineon.com)).

## **WARNINGS**

Due to technical requirements products may contain dangerous substances. For information on the types in question please contact your nearest Infineon Technologies office.

Except as otherwise explicitly approved by Infineon Technologies in a written document signed by authorized representatives of Infineon Technologies, Infineon Technologies' products may not be used in any applications where a failure of the product or any consequences of the use thereof can reasonably be expected to result in personal injury.