

PCB LAYOUT * - COMPONENT VIEW

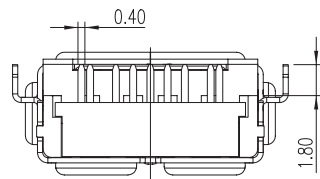
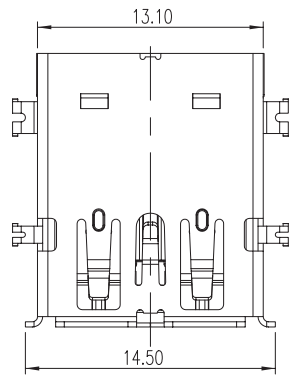
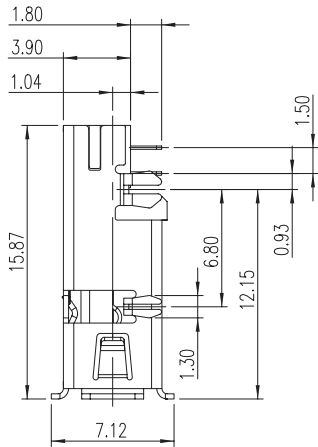

TECHNICAL CHARACTERISTICS

MATERIAL
 INSULATOR: LCP
 FLAMMABILITY RATING: UL94-V0
 COLOR: BLUE
 CONTACT MATERIAL: PHOSPHOR BRONZE
 CONTACT TYPE: STAMPED
 CONTACT PLATING: UNDERPLATE 1.27 to 2.54 μm Ni
 CONTACT AREA 0.76 μm Gold
 SOLDER TAIL AREA 2.54 to 5.08 μm Matt Tin
 SHIELDING: BRASS MATT TIN PLATED
 QUALITY CLASS: 5000 MATING CYCLES

ENVIRONMENTAL
 OPERATING TEMPERATURE: -20°C up to +85°C
 COMPLIANCE: LEAD FREE & RoHS

ELECTRICAL
 CURRENT RATING:
 - PIN 1 & PIN 4 (Vbus & corresponding ground PIN) 1.8A MAX
 - OTHER PINS 0.25 A MAX
 WORKING VOLTAGE: 30 VAC
 DIELECTRIC WITHSTANDING VOLTAGE: 100 VAC/MIN
 INSULATION RESISTANCE: > 100 M Ω
 CONTACT RESISTANCE:
 - PIN 1 & PIN 4: 30 m Ω MAX
 - OTHER PINS: 50 m Ω MAX



STANDARD
 CERTIFIED: E323964

MECHANICAL
 INSERTION FORCE: 35.0N MAX
 EXTRACTION FORCE: 10.0N MIN

SOLDERING
 JEDEC LEAD FREE REFLOW & WAVE SOLDERING

PACKAGING
 TAPE & REEL

* NOTE: THE RECOMMENDED PCB LAYOUT IS FOR AN OPTIMIZED RETENTION FORCE OF CONNECTOR ON PCB BUT IT IMPLIES INSERTION FORCE THAT A LOT OF PICK AND PLACE MACHINES ARE NOT ABLE TO HANDLE. THEREFORE IT MIGHT BE NECESSARY TO DRILL BIGGER HOLES FOR THE CLIPS. PLEASE CHECK THIS CAREFULLY.

RoHS Compliant				PROJECTION: 	GENERAL TOLERANCE .X = +/- 0.2 .XX = +/- 0.15	 WÜRTH ELEKTRONIK	DESCRIPTION: WR-COM - USB 3.0 HORIZONTAL TYPE A WITH OFFSET 1.04 MM	SIZE A4
APPROVAL: NPr				UNIT: MM	SHEET: 1/3 DRAW: AS			
H	17-JUL-17	SOLDERING	AK					
REV	DATE	FILE	BY					

1

2

3

4

5

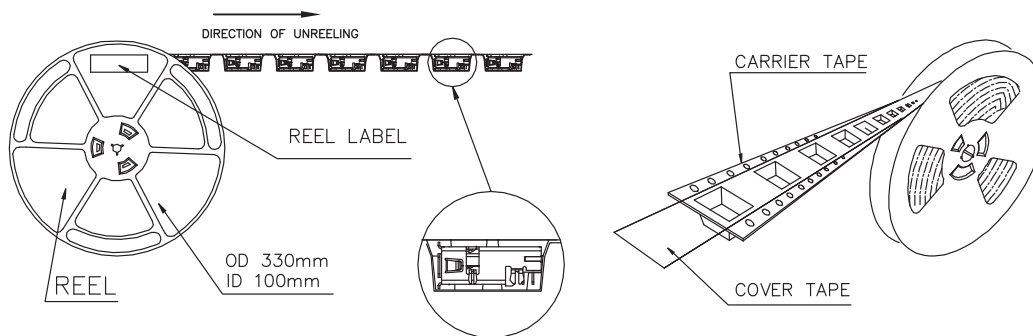
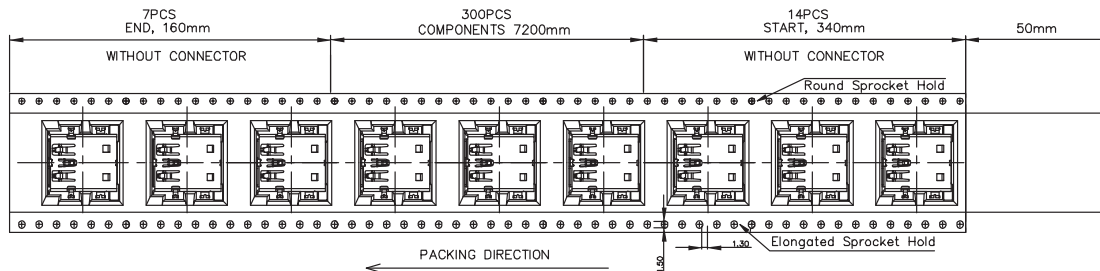
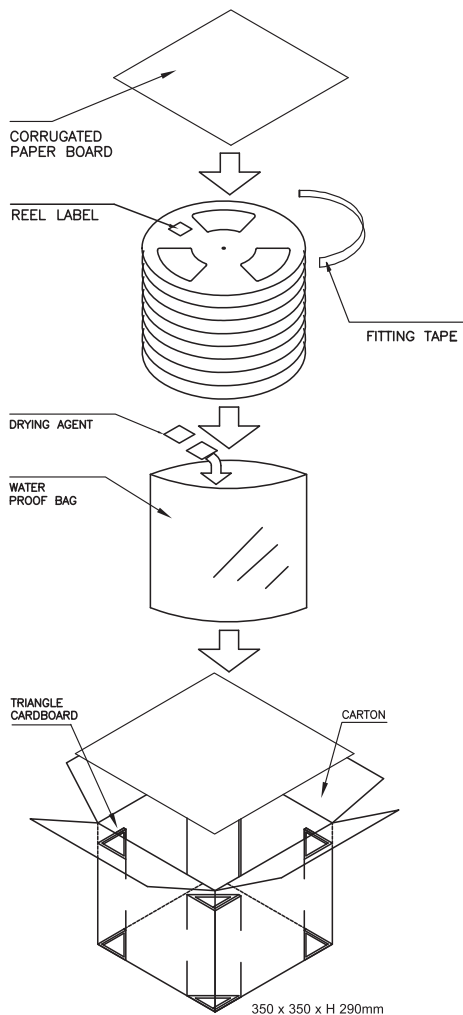

NOTES
 1. MATERIALS: PS
 2. 1500PCS/CARTON
 3. RoHS
 All Material in According With The Rohs Environment
 Related Substances List Controlled.

RoHS Compliant				PROJECTION: 	GENERAL TOLERANCE .X = +/- 0.2 .XX = +/- 0.15		DESCRIPTION: WR-COM - USB 3.0 HORIZONTAL TYPE A WITH OFFSET 1.04 MM	SIZE A4
G								
F								
E								
D				APPROVAL: NPr	UNIT: MM	WERI PART NO: 692 121 230 100		
C					SCALE:			
B					SHEET: 2/3			
A				DRAW: AS				
REV	DATE	FILE	BY					

1

2

3

4

5

Cautions and Warnings:

This electronic component is designed and developed with the intention for use in general electronics equipments.

Before incorporating the components into any equipments in the field such as aerospace, aviation, nuclear control, submarine, transportation, (automotive control, train control, ship control), transportation signal, disaster prevention, medical, public information network etc. where higher safety and reliability are especially required or if there is possibility of direct damage or injury to human body, Würth Elektronik must be asked for a written approval.

In addition, even electronic component in general electronic equipments, when used in electrical circuits that require high safety, reliability functions or performance, the sufficient reliability evaluation-check for the safety must be performed before by the user before usage.

A

B

C

RoHS Compliant

G				PROJECTION: 	GENERAL TOLERANCE .X = +/- 0.2 .XX = +/- 0.15		
F							
E							
D							
C				APPROVAL: JC	UNIT: MM	DESCRIPTION: DISCLAIMER	SIZE A4
B					SCALE:		
A	10-SEP-14	PDF	QL		SHEET: 3/3	WERI PART NO: DISCLAIMER	
REV	DATE	FILE	BY		DRAW: QL		

D