

DESCRIPTION: M5 MALE - CABLE MOUNT - SOLDER CUP - 4 POSITION - SHIELDED

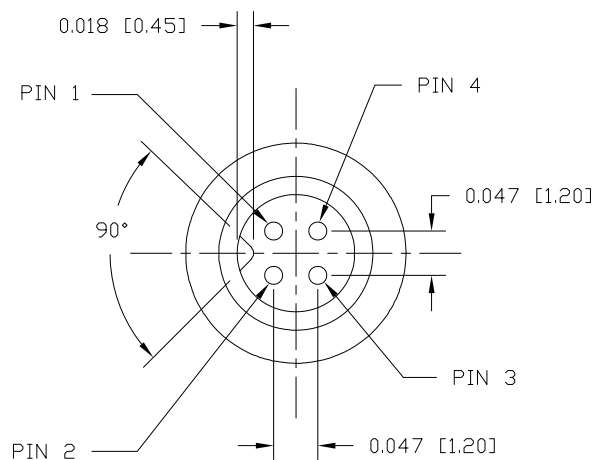

NOTE:

MATERIAL	
HOUSING:	TPU, BLACK
CONTACT:	BRASS
NUT:	BRASS
SHELL:	BRASS
FINISH	
CONTACT:	GOLD PLATED
	OVER 50µ" NICKEL
NUT:	NICKEL PLATED
SHELL:	BRIGHT TIN PLATED
ELECTRICAL	
RATED CURRENT:	1A
RATED VOLTAGE:	60V
INSULATION RESISTANCE:	100 MΩhms MIN.
CONTACT RESISTANCE:	10 mΩhms MAX.
WATER PROOF:	IP67
ENVIRONMENT	
OPERATION TEMPERATURE:	-40°C TO +85°C
WIRE GAUGE:	28 AWG MAX RECOMMENDED

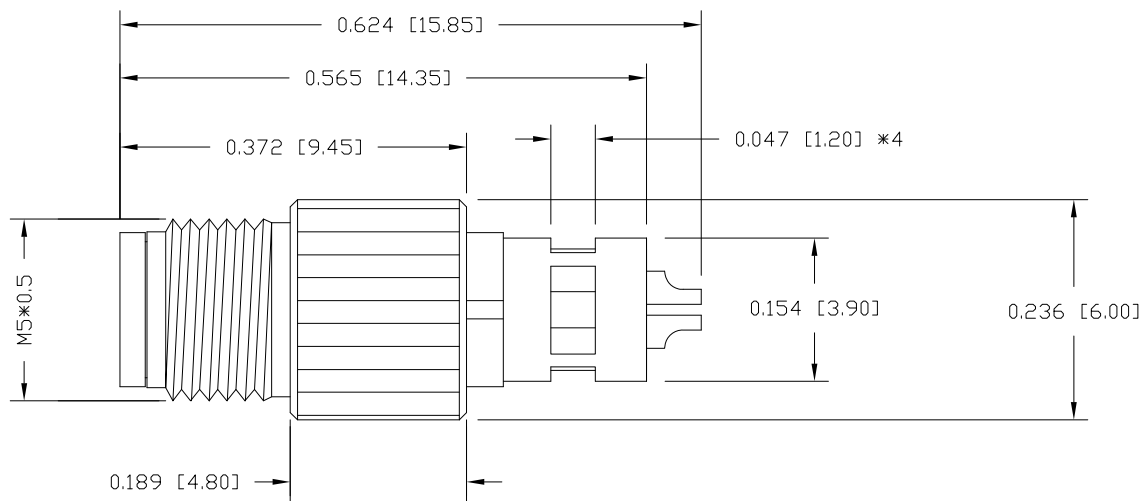

850-004-103RLSY

1 = GOLD FLASH
4 = 10µ" GOLD

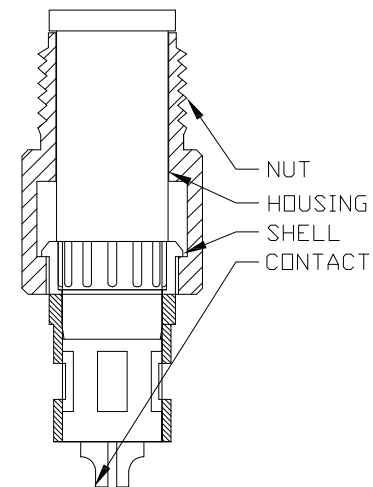

RoHS COMPLIANT

UNITS = inch [mm]

DO NOT SCALE FROM DRAWING



THESE DRAWINGS AND SPECIFICATIONS ARE THE PROPERTY OF NorComp AND SHALL NOT BE REPRODUCED, COPIED OR USED AS THE BASIS FOR THE MANUFACTURE OR SALE OF APPARATUS WITHOUT WRITTEN PERMISSION.

DRAWN: M. SIGMON

DATE: 03-04-16

NorComp

SCALE: NTS

SHEET 1 OF 1

REV 5

DWG NO. 850-004-103RLSY