

In case of consideration for using Automotive equipment / device which demand high reliability, kindly contact our sales window.

△數 COUNT	訂正事項 DESCRIPTION OF REVISIONS	擔當 B Y	檢圖 CHKD	年月日 DATE	△數 COUNT	訂正事項 DESCRIPTION OF REVISIONS	擔當 B Y	檢圖 CHKD	年月日 DATE
1	RE-6-1150	K.I.Y	L.S.M	18. 07. 04					
2	RE-6-1579	K.I.Y	L.S.M	20. 01. 23					

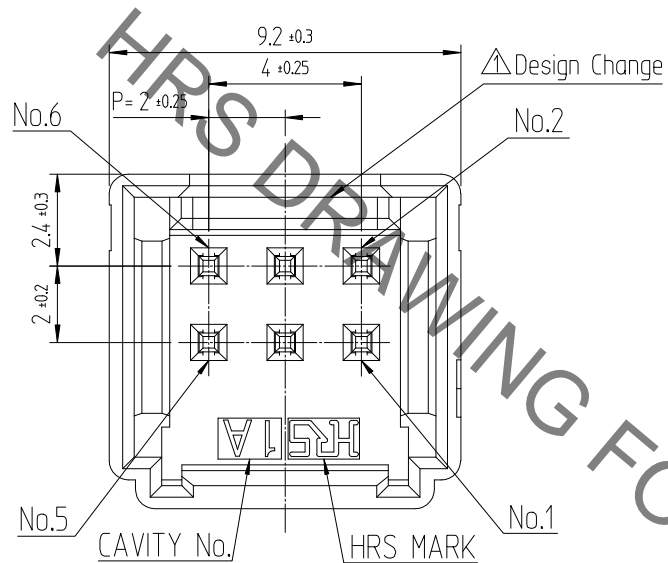

RECOMMENDED LAND PATTERN (FREE)
(PCB THICKNESS t=1.6mm)

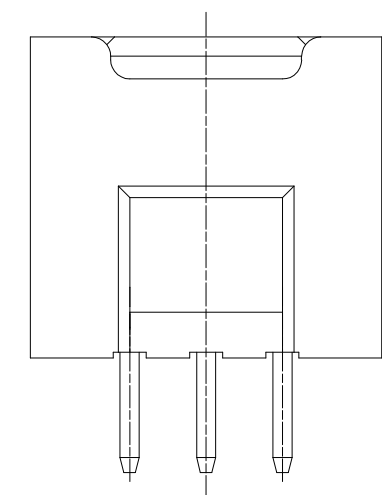
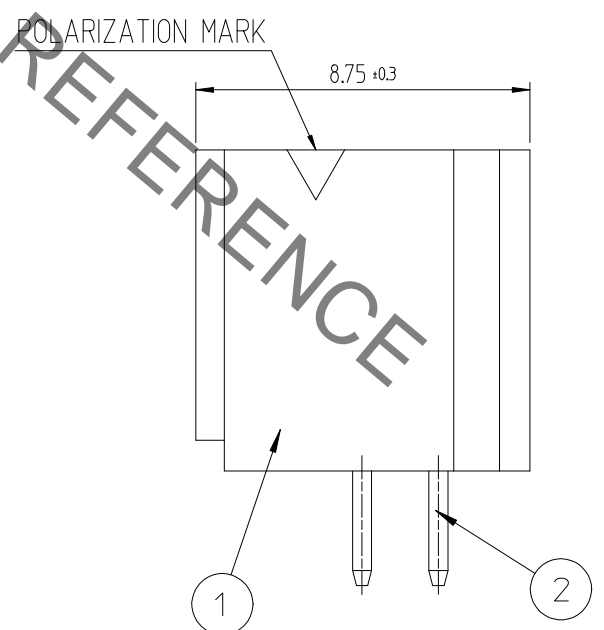
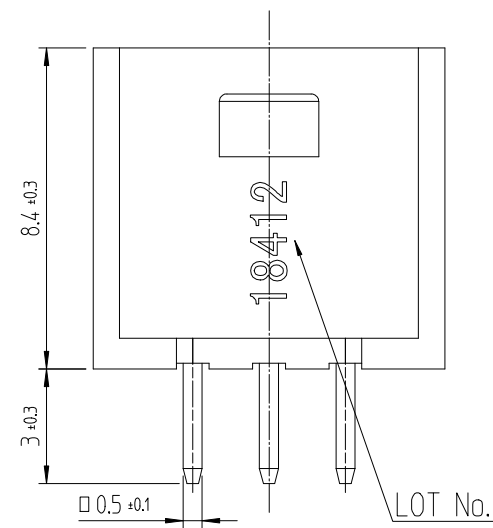
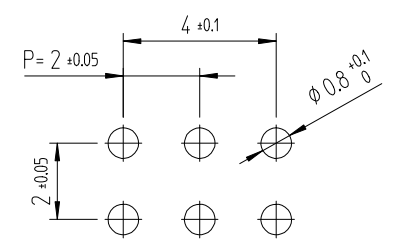

ENGAGEMENT FIGURE (2:1)

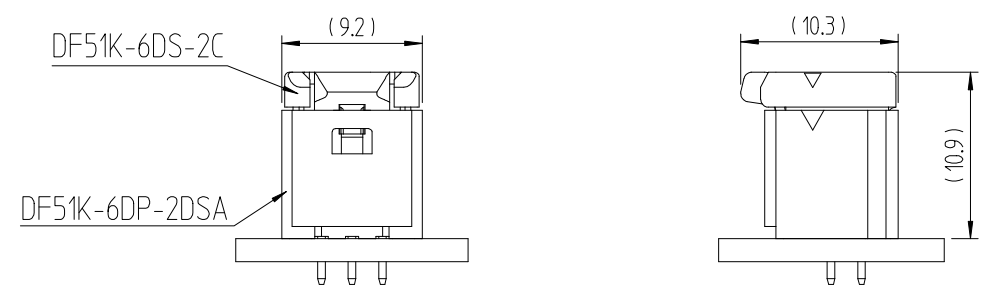

NOTE 1. 1PACK CONTAINS 100PCS.
2. () DIMENSIONS ARE ONLY REFERENCE.
△ 3. UL(File No. E132750) AUTHORIZATION ARTICLE.
C-UL(File No. E132750) AUTHORIZATION ARTICLE.



1	△ PA66	UL94V-0, BLACK	2	BRASS	TIN PLATING 1μm MIN, OVER NICKEL 0.5μm MIN
NO.	MATERIAL	FINISH,REMARKS	NO.	MATERIAL	FINISH,REMARKS
CODE NO. (OLD)			DRAWN	DESIGNED	CHECKED
			CHOI 17.12.22 J.S	CHOI 17.12.22 J.S	LIM 17.12.22 S.M
			APPROVED	RELEASED	
			KANG 17.12.22 T.S	ENG 20.02.12 DEPT	
DRAWING NO. EDC3-632458			PART NO. DF51K-6DP-2DSA (800)		
SCALE 5:1			CODE NO. CL 6652-0007-8-800		
UNITS mm			HRS HIROSE KOREA CO.,LTD.		
					1/1