

TIP41G, TIP41AG, TIP41BG, TIP41CG (NPN), TIP42G, TIP42AG, TIP42BG, TIP42CG (PNP)

Complementary Silicon Plastic Power Transistors

Designed for use in general purpose amplifier and switching applications.

Features

- Epoxy Meets UL 94 V-0 @ 0.125 in
- These Devices are Pb-Free and are RoHS Compliant*

MAXIMUM RATINGS

Rating	Symbol	Value	Unit
Collector-Emitter Voltage TIP41G, TIP42G TIP41AG, TIP42AG TIP41BG, TIP42BG TIP41CG, TIP42CG	V_{CE0}	40 60 80 100	Vdc
Collector-Base Voltage TIP41G, TIP42G TIP41AG, TIP42AG TIP41BG, TIP42BG TIP41CG, TIP42CG	V_{CB}	40 60 80 100	Vdc
Emitter-Base Voltage	V_{EB}	5.0	Vdc
Collector Current - Continuous	I_C	6.0	Adc
Collector Current - Peak	I_{CM}	10	Adc
Base Current	I_B	2.0	Adc
Total Power Dissipation @ $T_C = 25^\circ\text{C}$ Derate above 25°C	P_D	65 0.52	W W/ $^\circ\text{C}$
Total Power Dissipation @ $T_A = 25^\circ\text{C}$ Derate above 25°C	P_D	2.0 0.016	W W/ $^\circ\text{C}$
Unclamped Inductive Load Energy (Note 1)	E	62.5	mJ
Operating and Storage Junction, Temperature Range	T_J, T_{stg}	-65 to +150	$^\circ\text{C}$
ESD - Human Body Model	HBM	3B	V
ESD - Machine Model	MM	C	V

Stresses exceeding those listed in the Maximum Ratings table may damage the device. If any of these limits are exceeded, device functionality should not be assumed, damage may occur and reliability may be affected.

1. $I_C = 2.5\text{ A}$, $L = 20\text{ mH}$, P.R.F. = 10 Hz, $V_{CC} = 10\text{ V}$, $R_{BE} = 100\ \Omega$.

*For additional information on our Pb-Free strategy and soldering details, please download the ON Semiconductor Soldering and Mounting Techniques Reference Manual, SOLDERRM/D.



ON Semiconductor®

www.onsemi.com

6 AMPERE COMPLEMENTARY SILICON POWER TRANSISTORS 40-60-80-100 VOLTS, 65 WATTS

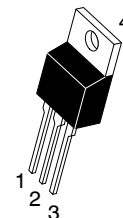
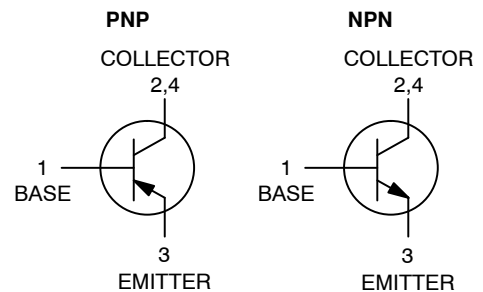

TO-220
CASE 221A
STYLE 1

MARKING DIAGRAM

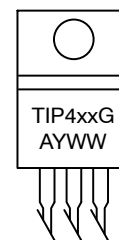

TIP4xx = Device Code
 xx = 1, 1A, 1B, 1C
 2, 2A, 2B, 2C
 A = Assembly Location
 Y = Year
 WW = Work Week
 G = Pb-Free Package

ORDERING INFORMATION

See detailed ordering and shipping information on page 6 of this data sheet.

TIP41G, TIP41AG, TIP41BG, TIP41CG (NPN), TIP42G, TIP42AG, TIP42BG, TIP42CG (PNP)

THERMAL CHARACTERISTICS

Characteristic	Symbol	Max	Unit
Thermal Resistance, Junction-to-Case	$R_{\theta JC}$	1.67	$^{\circ}\text{C}/\text{W}$
Thermal Resistance, Junction-to-Ambient	$R_{\theta JA}$	57	$^{\circ}\text{C}/\text{W}$

ELECTRICAL CHARACTERISTICS ($T_C = 25^{\circ}\text{C}$ unless otherwise noted)

Characteristic	Symbol	Min	Max	Unit
----------------	--------	-----	-----	------

OFF CHARACTERISTICS

Collector-Emitter Sustaining Voltage (Note 2) ($I_C = 30 \text{ mAdc}$, $I_B = 0$) TIP41G, TIP42G TIP41AG, TIP42AG TIP41BG, TIP42BG TIP41CG, TIP42CG	$V_{CEO(sus)}$	40 60 80 100	- - - -	Vdc
Collector Cutoff Current ($V_{CE} = 30 \text{ Vdc}$, $I_B = 0$) TIP41G, TIP41AG, TIP42G, TIP42AG ($V_{CE} = 60 \text{ Vdc}$, $I_B = 0$) TIP41BG, TIP41CG, TIP42BG, TIP42CG	I_{CEO}	- -	0.7 0.7	mAdc
Collector Cutoff Current ($V_{CE} = 40 \text{ Vdc}$, $V_{EB} = 0$) TIP41G, TIP42G ($V_{CE} = 60 \text{ Vdc}$, $V_{EB} = 0$) TIP41AG, TIP42AG ($V_{CE} = 80 \text{ Vdc}$, $V_{EB} = 0$) TIP41BG, TIP42BG ($V_{CE} = 100 \text{ Vdc}$, $V_{EB} = 0$) TIP41CG, TIP42CG	I_{CES}	- - - -	400 400 400 400	μAdc
Emitter Cutoff Current ($V_{BE} = 5.0 \text{ Vdc}$, $I_C = 0$)	I_{EBO}	-	1.0	mAdc

ON CHARACTERISTICS (Note 2)

DC Current Gain ($I_C = 0.3 \text{ Adc}$, $V_{CE} = 4.0 \text{ Vdc}$) ($I_C = 3.0 \text{ Adc}$, $V_{CE} = 4.0 \text{ Vdc}$)	h_{FE}	30 15	- 75	-
Collector-Emitter Saturation Voltage ($I_C = 6.0 \text{ Adc}$, $I_B = 600 \text{ mAdc}$)	$V_{CE(sat)}$	-	1.5	Vdc
Base-Emitter On Voltage ($I_C = 6.0 \text{ Adc}$, $V_{CE} = 4.0 \text{ Vdc}$)	$V_{BE(on)}$	-	2.0	Vdc

DYNAMIC CHARACTERISTICS

Current-Gain - Bandwidth Product ($I_C = 500 \text{ mAdc}$, $V_{CE} = 10 \text{ Vdc}$, $f_{test} = 1.0 \text{ MHz}$)	f_T	3.0	-	MHz
Small-Signal Current Gain ($I_C = 0.5 \text{ Adc}$, $V_{CE} = 10 \text{ Vdc}$, $f = 1.0 \text{ kHz}$)	h_{fe}	20	-	-

Product parametric performance is indicated in the Electrical Characteristics for the listed test conditions, unless otherwise noted. Product performance may not be indicated by the Electrical Characteristics if operated under different conditions.

2. Pulse Test: Pulse Width $\leq 300 \mu\text{s}$, Duty Cycle $\leq 2.0\%$.

TIP41G, TIP41AG, TIP41BG, TIP41CG (NPN), TIP42G, TIP42AG, TIP42BG, TIP42CG (PNP)

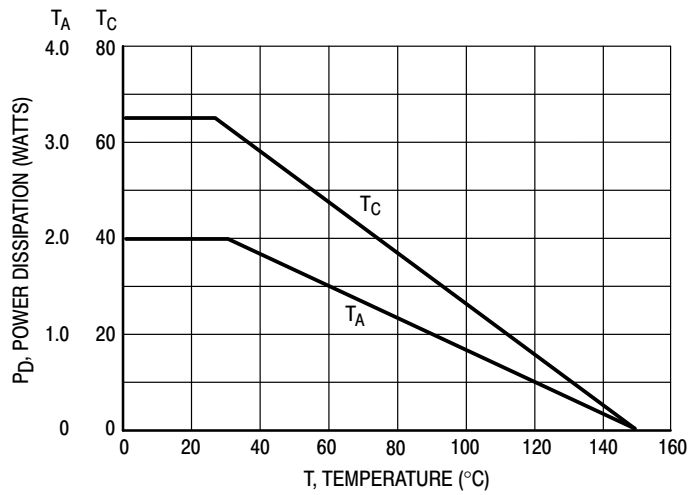
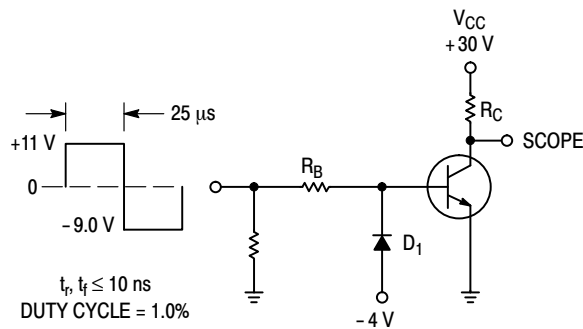

Figure 1. Power Derating



R_B and R_C VARIED TO OBTAIN DESIRED CURRENT LEVELS
 D_1 MUST BE FAST RECOVERY TYPE, e.g.:
 1N5825 USED ABOVE $I_B \approx 100 \text{ mA}$
 MSD6100 USED BELOW $I_B \approx 100 \text{ mA}$

Figure 2. Switching Time Test Circuit

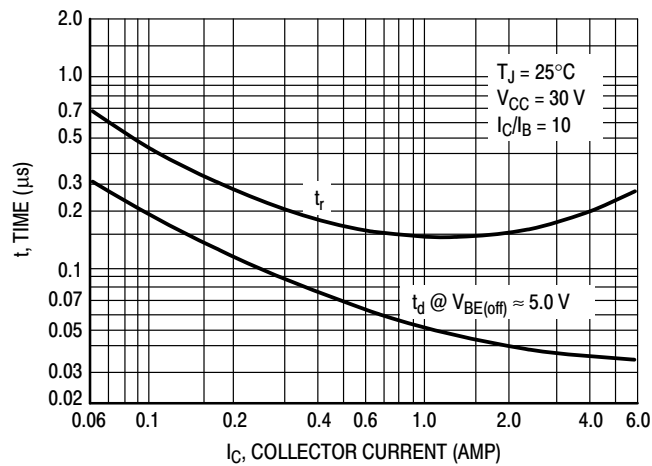

Figure 3. Turn-On Time

TIP41G, TIP41AG, TIP41BG, TIP41CG (NPN), TIP42G, TIP42AG, TIP42BG, TIP42CG (PNP)

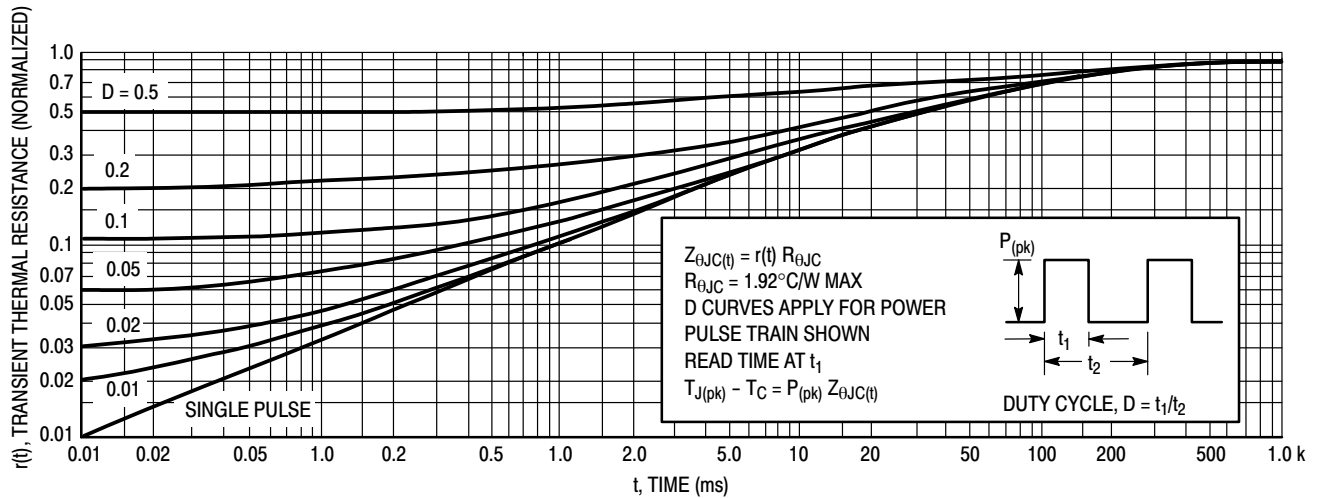

Figure 4. Thermal Response

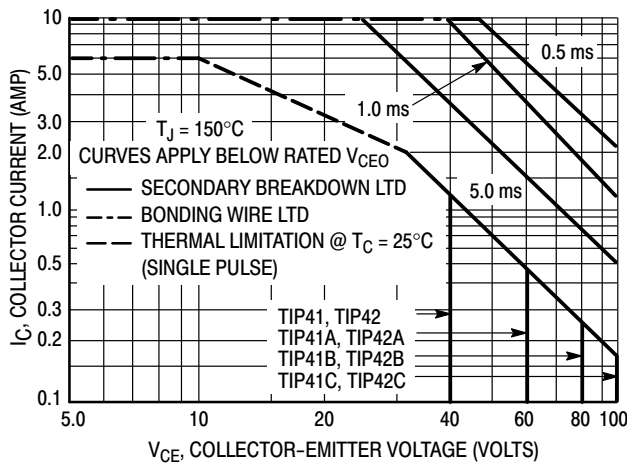

Figure 5. Active-Region Safe Operating Area

There are two limitations on the power handling ability of a transistor: average junction temperature and second breakdown. Safe operating area curves indicate $I_C - V_{CE}$ limits of the transistor that must be observed for reliable operation; i.e., the transistor must not be subjected to greater dissipation than the curves indicate.

The data of Figure 5 is based on $T_{J(pk)} = 150^{\circ}\text{C}$; T_C is variable depending on conditions. Second breakdown pulse limits are valid for duty cycles to 10% provided $T_{J(pk)} \leq 150^{\circ}\text{C}$. $T_{J(pk)}$ may be calculated from the data in Figure 4. At high case temperatures, thermal limitations will reduce the power that can be handled to values less than the limitations imposed by second breakdown.

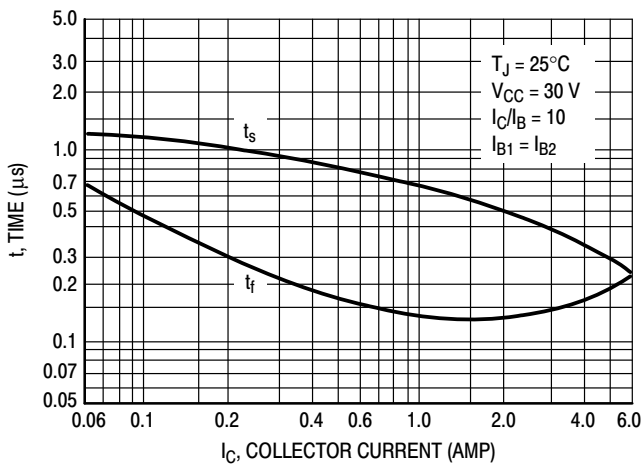

Figure 6. Turn-Off Time

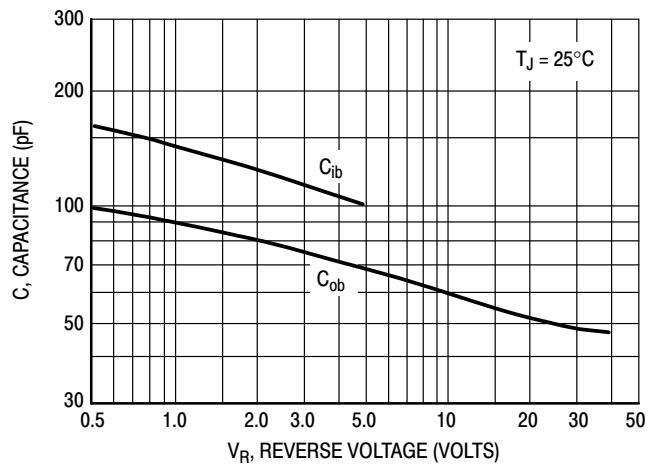

Figure 7. Capacitance

TIP41G, TIP41AG, TIP41BG, TIP41CG (NPN), TIP42G, TIP42AG, TIP42BG, TIP42CG (PNP)

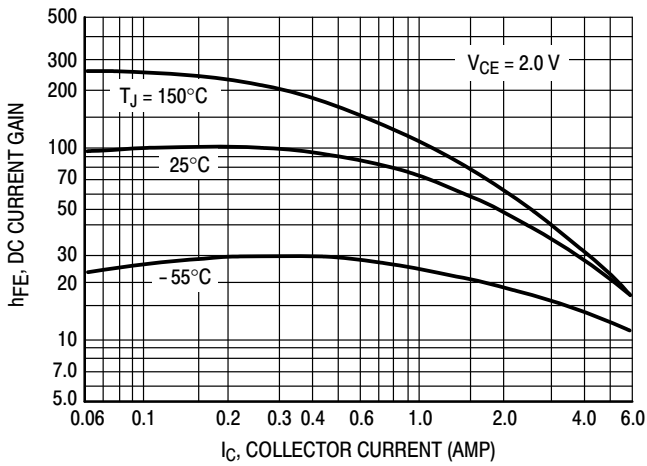

Figure 8. DC Current Gain

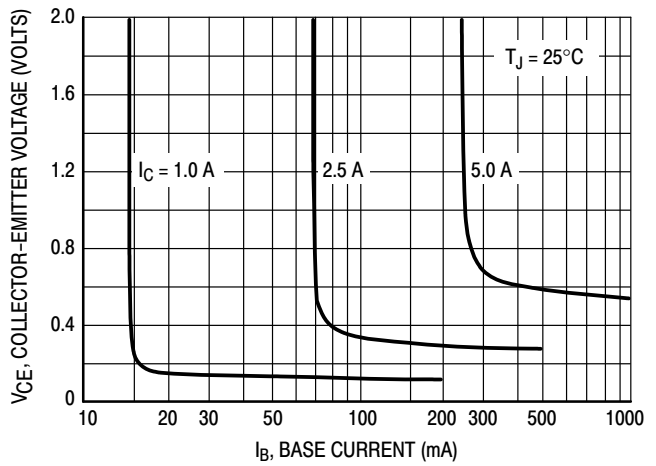

Figure 9. Collector Saturation Region

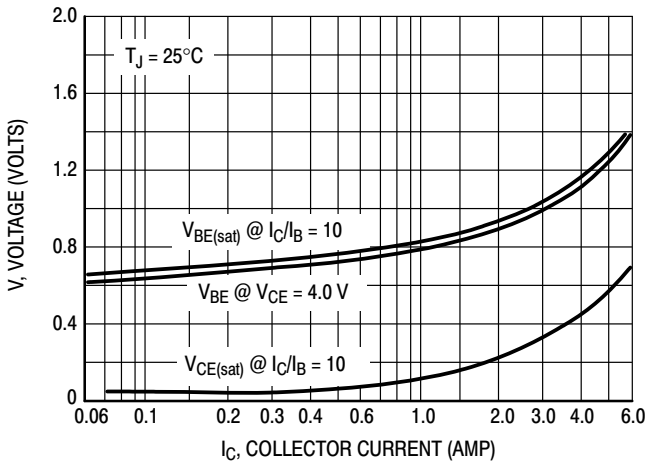

Figure 10. "On" Voltages

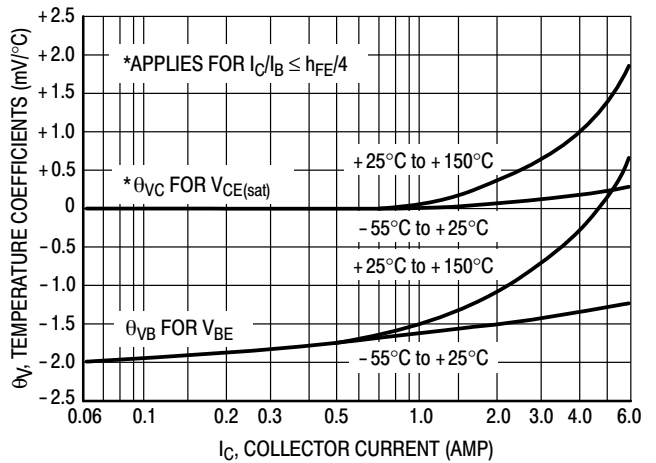

Figure 11. Temperature Coefficients

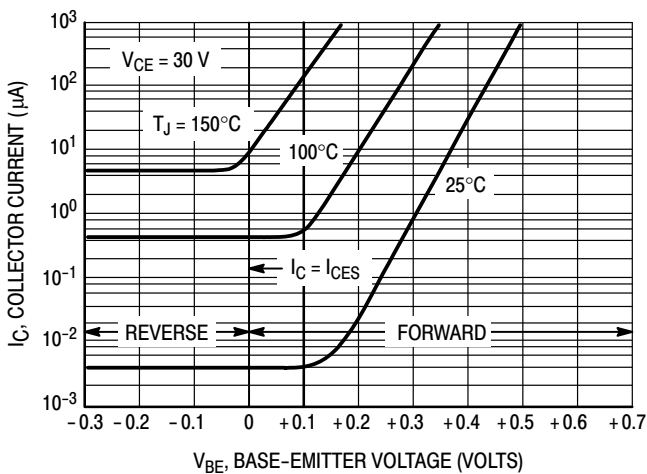

Figure 12. Collector Cut-Off Region

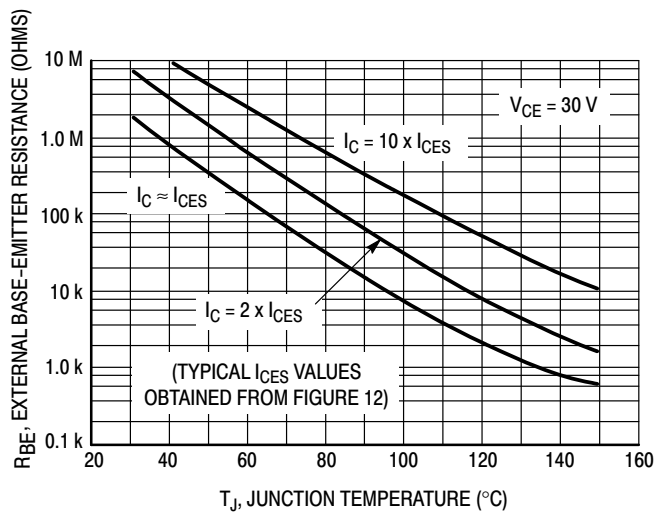

Figure 13. Effects of Base-Emitter Resistance

**TIP41G, TIP41AG, TIP41BG, TIP41CG (NPN), TIP42G, TIP42AG, TIP42BG,
TIP42CG (PNP)**

ORDERING INFORMATION

Device	Package	Shipping
TIP41G	TO-220 (Pb-Free)	50 Units / Rail
TIP41AG	TO-220 (Pb-Free)	50 Units / Rail
TIP41BG	TO-220 (Pb-Free)	50 Units / Rail
TIP41CG	TO-220 (Pb-Free)	50 Units / Rail
TIP42G	TO-220 (Pb-Free)	50 Units / Rail
TIP42AG	TO-220 (Pb-Free)	50 Units / Rail
TIP42BG	TO-220 (Pb-Free)	50 Units / Rail
TIP42CG	TO-220 (Pb-Free)	50 Units / Rail

MECHANICAL CASE OUTLINE PACKAGE DIMENSIONS

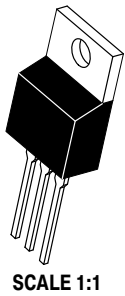

TO-220 CASE 221A ISSUE AK

DATE 13 JAN 2022

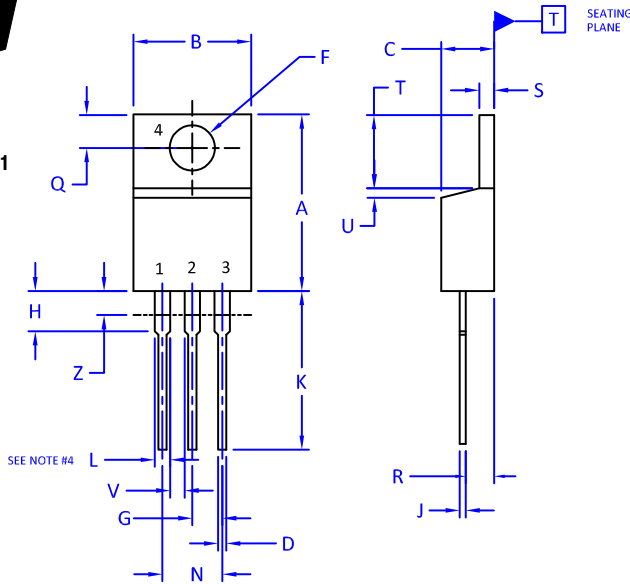

- NOTES:
1. DIMENSIONING AND TOLERANCING PER ANSI Y14.5M, 2009.
 2. CONTROLLING DIMENSION: INCHES
 3. DIMENSION Z DEFINES A ZONE WHERE ALL BODY AND LEAD IRREGULARITIES ARE ALLOWED.
 4. MAX WIDTH FOR F102 DEVICE = 1.35MM

DIM	INCHES		MILLIMETERS	
	MIN.	MAX.	MIN.	MAX.
A	0.570	0.620	14.48	15.75
B	0.380	0.415	9.66	10.53
C	0.160	0.190	4.07	4.83
D	0.025	0.038	0.64	0.96
F	0.142	0.161	3.60	4.09
G	0.095	0.105	2.42	2.66
H	0.110	0.161	2.80	4.10
J	0.014	0.024	0.36	0.61
K	0.500	0.562	12.70	14.27
L	0.045	0.060	1.15	1.52
N	0.190	0.210	4.83	5.33
Q	0.100	0.120	2.54	3.04
R	0.080	0.110	2.04	2.79
S	0.045	0.055	1.15	1.41
T	0.235	0.255	5.97	6.47
U	0.000	0.050	0.00	1.27
V	0.045	---	1.15	---
Z	---	0.080	---	2.04

STYLE 1:
PIN 1. BASE
2. COLLECTOR
3. EMITTER
4. COLLECTOR

STYLE 2:
PIN 1. BASE
2. EMITTER
3. COLLECTOR
4. EMITTER

STYLE 3:
PIN 1. CATHODE
2. ANODE
3. GATE
4. ANODE

STYLE 4:
PIN 1. MAIN TERMINAL 1
2. MAIN TERMINAL 2
3. GATE
4. MAIN TERMINAL 2

STYLE 5:
PIN 1. GATE
2. DRAIN
3. SOURCE
4. DRAIN

STYLE 6:
PIN 1. ANODE
2. CATHODE
3. ANODE
4. CATHODE

STYLE 7:
PIN 1. CATHODE
2. ANODE
3. CATHODE
4. ANODE

STYLE 8:
PIN 1. CATHODE
2. ANODE
3. EXTERNAL TRIP/DELAY
4. ANODE

STYLE 9:
PIN 1. GATE
2. COLLECTOR
3. EMITTER
4. COLLECTOR

STYLE 10:
PIN 1. GATE
2. SOURCE
3. DRAIN
4. SOURCE

STYLE 11:
PIN 1. DRAIN
2. SOURCE
3. GATE
4. SOURCE

STYLE 12:
PIN 1. MAIN TERMINAL 1
2. MAIN TERMINAL 2
3. GATE
4. NOT CONNECTED

DOCUMENT NUMBER:	98ASB42148B	Electronic versions are uncontrolled except when accessed directly from the Document Repository. Printed versions are uncontrolled except when stamped "CONTROLLED COPY" in red.
DESCRIPTION:	TO-220	PAGE 1 OF 1

onsemi and onsemi are trademarks of Semiconductor Components Industries, LLC dba onsemi or its subsidiaries in the United States and/or other countries. onsemi reserves the right to make changes without further notice to any products herein. onsemi makes no warranty, representation or guarantee regarding the suitability of its products for any particular purpose, nor does onsemi assume any liability arising out of the application or use of any product or circuit, and specifically disclaims any and all liability, including without limitation special, consequential or incidental damages. onsemi does not convey any license under its patent rights nor the rights of others.

onsemi, **Onsemi**, and other names, marks, and brands are registered and/or common law trademarks of Semiconductor Components Industries, LLC dba "**onsemi**" or its affiliates and/or subsidiaries in the United States and/or other countries. **onsemi** owns the rights to a number of patents, trademarks, copyrights, trade secrets, and other intellectual property. A listing of **onsemi**'s product/patent coverage may be accessed at www.onsemi.com/site/pdf/Patent-Marking.pdf. **onsemi** reserves the right to make changes at any time to any products or information herein, without notice. The information herein is provided "as-is" and **onsemi** makes no warranty, representation or guarantee regarding the accuracy of the information, product features, availability, functionality, or suitability of its products for any particular purpose, nor does **onsemi** assume any liability arising out of the application or use of any product or circuit, and specifically disclaims any and all liability, including without limitation special, consequential or incidental damages. Buyer is responsible for its products and applications using **onsemi** products, including compliance with all laws, regulations and safety requirements or standards, regardless of any support or applications information provided by **onsemi**. "Typical" parameters which may be provided in **onsemi** data sheets and/or specifications can and do vary in different applications and actual performance may vary over time. All operating parameters, including "Typicals" must be validated for each customer application by customer's technical experts. **onsemi** does not convey any license under any of its intellectual property rights nor the rights of others. **onsemi** products are not designed, intended, or authorized for use as a critical component in life support systems or any FDA Class 3 medical devices or medical devices with a same or similar classification in a foreign jurisdiction or any devices intended for implantation in the human body. Should Buyer purchase or use **onsemi** products for any such unintended or unauthorized application, Buyer shall indemnify and hold **onsemi** and its officers, employees, subsidiaries, affiliates, and distributors harmless against all claims, costs, damages, and expenses, and reasonable attorney fees arising out of, directly or indirectly, any claim of personal injury or death associated with such unintended or unauthorized use, even if such claim alleges that **onsemi** was negligent regarding the design or manufacture of the part. **onsemi** is an Equal Opportunity/Affirmative Action Employer. This literature is subject to all applicable copyright laws and is not for resale in any manner.

PUBLICATION ORDERING INFORMATION

LITERATURE FULFILLMENT:

Email Requests to: orderlit@onsemi.com

onsemi Website: www.onsemi.com

TECHNICAL SUPPORT

North American Technical Support:

Voice Mail: 1 800-282-9855 Toll Free USA/Canada

Phone: 011 421 33 790 2910

Europe, Middle East and Africa Technical Support:

Phone: 00421 33 790 2910

For additional information, please contact your local Sales Representative