

Current Transducer HLSR-SM/SP33 series $I_{PN} = 10 \dots 50 \text{ A}$

Ref: **HLSR 10-SM/SP33, HLSR 20-SM/SP33, HLSR 32-SM/SP33, HLSR 40-SM/SP33, HLSR 50-SM/SP33**

For the electronic measurement of current: DC, AC, pulsed..., with galvanic separation between the primary and the secondary circuit.

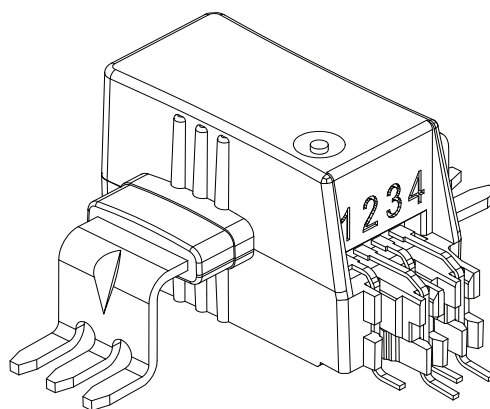

Features

- Open loop multi-range current transducer
- Voltage output
- Galvanic separation between primary and secondary
- Low power consumption
- Compact design for surface mount PCB mounting
- Factory calibrated
- High bandwidth, very low loss magnetic core.

Special feature

- Single supply +3.3 V.

Advantages

- Extremely low profile: $h = 12 \text{ mm}$
- Low foot-print
- Low offset drift
- Over-drivable U_{ref} .

Applications

- AC variable speed and servo motor drives
- Static converters for DC motor drives
- Battery supplied applications
- Uninterruptible Power Supplies (UPS)
- Switched Mode Power Supplies (SMPS)
- Power supplies for welding applications
- Combiner box
- MPPT.

Standards

- EN 50178: 1997
- IEC 61010-1: 2010
- IEC 61326-1: 2012
- UL 508: 2010.

Application Domain

- Industrial.

Absolute maximum ratings

Parameter	Symbol	Unit	Value
Supply voltage (not destructive)	U_C	V	8
Supply voltage (not entering non standard modes)	U_C	V	6.5
Primary conductor temperature	T_B	°C	120
Electrostatic discharge voltage (HBM - Human Body Model)	$U_{ESD\ HBM}$	kV	2

Stresses above these ratings may cause permanent damage.
Exposure to absolute maximum ratings for extended periods may degrade reliability.

UL 508: Ratings and assumptions of certification

File # E189713 Volume: 2 Section: 5

Standards

- CSA C22.2 NO. 14-10 INDUSTRIAL CONTROL EQUIPMENT - Edition 11 - Revision Date 2011/08/01
- UL 508 STANDARD FOR INDUSTRIAL CONTROL EQUIPMENT - Edition 17 - Revision Date 2010/04/15

Ratings

Parameter	Symbol	Unit	Comment
Primary involved potential		V AC/DC	600
Max surrounding air temperature	T_A	°C	105
Primary current	I_P	A	According to series primary current
Secondary supply voltage	U_C	V DC	5
Output voltage	U_{out}	V	0 to 5

Conditions of acceptability

- 1 - These devices have been evaluated for overvoltage category III and for use in pollution degree 2 environment.
- 2 - A suitable enclosure shall be provided in the end-use application.
- 3 - The terminals have not been evaluated for field wiring.
- 4 - These devices are intended to be mounted on a printed wiring board of end use equipment. The suitability of the connections (including spacings) shall be determined in the end-use application.
- 5 - Primary terminals shall not be straightened since assembly of housing case depends upon bending of the terminals.
- 6 - Any surface of polymeric housing have not been evaluated as insulating barrier.
- 7 - Low voltage control circuit shall be supplied by an isolating source (such as a transformer, optical isolator, limiting impedance or electro-mechanical relay).

Marking

Only those products bearing the UR Mark should be considered to be Listed or Recognized and covered under UL's Follow-Up Service. Always look for the Mark on the product.

Insulation coordination

Parameter	Symbol	Unit	≤ Value	Comment
RMS voltage for AC insulation test, 50/60 Hz, 1 min	U_d	kV	4.3	
Impulse withstand voltage 1.2/50 μ s	U_{Ni}	kV	8	
Clearance (pri. - sec.)	d_{Cl}	mm	8	Shortest distance through air
Creepage distance (pri. - sec.)	d_{Cp}	mm	8	Shortest path along device body
Clearance (pri. - sec.)	-	mm	8	When mounted on PCB with recommended layout
Case material	-	-	V0	According to UL 94
Comparative tracking index	<i>CTI</i>		600	
Application example		V	600	Reinforced insulation, CAT III, PD2, non uniform field according to EN 50178, IEC 61010
Application example		V	1000	Basic insulation, CAT III, PD2, non uniform field according to EN 50178, IEC 61010
Application example		V	600	According to UL 508

Environmental and mechanical characteristics

Parameter	Symbol	Unit	Min	Typ	Max	Comment
Ambient operating temperature	T_A	°C	-40		105	
Ambient storage temperature	T_{Ast}	°C	-40		105	
Mass	m	g			5	

Electrical data HLSR 10-SM/SP33

 At $T_A = 25\text{ °C}$, $U_C = +3.3\text{ V}$, $R_L = 10\text{ k}\Omega$ unless otherwise noted (see Min, Max, typ, definition paragraph in page 9).

Parameter	Symbol	Unit	Min	Typ	Max	Comment
Primary nominal RMS current	I_{PN}	A		10		
Primary current, measuring range	I_{PM}	A	-25		25	For $U_C = +3.3\text{ V} \pm 5\%$
Number of primary turns	N_p	-		1		
Resistance of primary jumper @ $T_A = 25\text{ °C}$	R_p	m Ω		0.21		
Resistance of primary jumper @ $T_A = 105\text{ °C}$	R_p	m Ω		0.29		T jumper = 120 °C
Supply voltage	U_C	V	3.135	3.3	3.465	
Current consumption	I_C	mA		19	25	
Reference voltage (output)	U_{ref}	V	1.63	1.65	1.67	Internal reference
Reference voltage (input)	U_{ref}	V	0.5		1.7	External reference
Output voltage range @ I_{PM}	$U_{out} - U_{ref}$	V	-1.15		1.15	Over operating temperature range
Internal series resistance of reference voltage	R_{ref}	Ω	130	200	300	series
Output internal resistance	R_{out}	Ω		2	5	series
Load capacitance	C_L	nF	0		6	
Electrical offset voltage referred to primary @ $I_P = 0$	U_{OE}	mV	-5		5	$U_{out} - U_{ref}$ @ $U_{ref} = 1.65\text{ V}$ Not guaranteed in REF IN mode with external reference $U_{ref} \neq 1.65\text{ V}$
Electrical offset current referred to primary	I_{OE}	mA	-109		109	
Temperature coefficient of U_{ref}	TCU_{ref}	ppm/K	-150		150	-40 °C ... 105 °C
Temperature coefficient of U_{OE} referred to primary	TCU_{OE}	mV/K	-0.075		0.075	
Temperature coefficient of I_{OE} referred to primary	TCI_{OE}	mA/K	-1.63		1.63	
Nominal sensitivity	S_N	mV/A		46		460 mV @ I_{PN}
Sensitivity error	ϵ_s	%	-0.5		0.5	Factory adjustment
Temperature coefficient of S	TCS	ppm/K	-200		200	
Linearity error 0 ... I_{PN}	ϵ_L	% of I_{PN}	-0.5		0.5	
Linearity error 0 ... I_{PM}	ϵ_L	% of I_{PM}	-0.8		0.8	
Magnetic offset current (@ $10 \times I_{PN}$) referred to primary	I_{OM}	A	-0.25		0.25	
Delay time @ 10 % of the final output value for I_{PN} step	t_{D10}	μ s			2	@ 50 A/ μ s
Delay time @ 90 % of the final output value for I_{PN} step	t_{D90}	μ s			2.5	@ 50 A/ μ s
Frequency bandwidth (-3 dB)	BW	kHz		450		
RMS noise voltage spectral density referred to primary 100 Hz ... 100 kHz	u_{no}	μ V/ $\sqrt{\text{Hz}}$			16	
RMS noise voltage referred to primary DC ... 10 kHz DC ... 100 kHz DC ... 1 MHz	U_{no}	mVpp		9 22 40		
Sum of sensitivity and linearity @ I_{PN}	ϵ_{SL}	% of I_{PN}	-1		1	
Sum of sensitivity and linearity @ I_{PN} @ $T_A = +85\text{ °C}$	$\epsilon_{SL85\text{ °C}}$	% of I_{PN}	-3.2		3.2	See formula note ¹⁾
Sum of sensitivity and linearity @ I_{PN} @ $T_A = +105\text{ °C}$	$\epsilon_{SL105\text{ °C}}$	% of I_{PN}	-3.9		3.9	See formula note ¹⁾

Note: ¹⁾ $\epsilon_{SL}(T_A) = \epsilon_{SL25} + \left(TCS + \frac{TCI_{OE}}{I_{PN}} \right) \times |T_A - 25|$

At $T_A = 25\text{ °C}$, $U_C = +3.3\text{ V}$, $R_L = 10\text{ k}\Omega$ unless otherwise noted (see Min, Max, typ, definition paragraph in page 9).

Parameter	Symbol	Unit	Min	Typ	Max	Comment
Primary nominal RMS current	I_{PN}	A		20		
Primary current, measuring range	I_{PM}	A	-50		50	For $U_C = +3.3\text{ V} \pm 5\%$
Number of primary turns	N_p	-		1		
Resistance of primary jumper @ $T_A = 25\text{ °C}$	R_p	m Ω		0.21		
Resistance of primary jumper @ $T_A = 105\text{ °C}$	R_p	m Ω		0.29		T jumper = 120 °C
Supply voltage	U_C	V	3.135	3.3	3.465	
Current consumption	I_C	mA		19	25	
Reference voltage (output)	U_{ref}	V	1.63	1.65	1.67	Internal reference
Reference voltage (input)	U_{ref}	V	0.5		1.7	External reference
Output voltage range @ I_{PM}	$U_{out} - U_{ref}$	V	-1.15		1.15	Over operating temperature range
Internal series resistance of reference voltage	R_{ref}	Ω	130	200	300	series
Output internal resistance	R_{out}	Ω		2	5	series
Load capacitance	C_L	nF	0		6	
Electrical offset voltage referred to primary @ $I_p = 0$	U_{OE}	mV	-5		5	$U_{out} - U_{ref}$ @ $U_{ref} = 1.65\text{ V}$ Not guaranteed in REF IN mode with external reference $U_{ref} \neq 1.65\text{ V}$
Electrical offset current referred to primary	I_{OE}	mA	-217		217	
Temperature coefficient of U_{ref}	TCU_{ref}	ppm/K	-150		150	-40 °C ... 105 °C
Temperature coefficient of U_{OE} referred to primary	TCU_{OE}	mV/K	-0.075		0.075	
Temperature coefficient of I_{OE} referred to primary	TCI_{OE}	mA/K	-3.26		3.26	
Nominal sensitivity	S_N	mV/A		23		460 mV @ I_{PN}
Sensitivity error	ε_s	%	-0.5		0.5	Factory adjustment
Temperature coefficient of S	TCS	ppm/K	-200		200	
Linearity error 0 ... I_{PN}	ε_L	% of I_{PN}	-0.5		0.5	
Linearity error 0 ... I_{PM}	ε_L	% of I_{PM}	-0.8		0.8	
Magnetic offset current (@ $10 \times I_{PN}$) referred to primary	I_{OM}	A	-0.25		0.25	
Delay time @ 10 % of the final output value for I_{PN} step	t_{D10}	μs			2	@ 50 A/ μs
Delay time @ 90 % of the final output value for I_{PN} step	t_{D90}	μs			2.5	@ 50 A/ μs
Frequency bandwidth (-3 dB)	BW	kHz		450		
RMS noise voltage spectral density referred to primary 100 Hz ... 100 kHz	u_{no}	$\mu\text{V}/\sqrt{\text{Hz}}$			8	
RMS noise voltage referred to primary DC ... 10 kHz DC ... 100 kHz DC ... 1 MHz	U_{no}	mVpp		6 13 23		
Sum of sensitivity and linearity @ I_{PN}	ε_{SL}	% of I_{PN}	-1		1	
Sum of sensitivity and linearity @ I_{PN} @ $T_A = +85\text{ °C}$	$\varepsilon_{SL85\text{ °C}}$	% of I_{PN}	-3.2		3.2	See formula note ¹⁾
Sum of sensitivity and linearity @ I_{PN} @ $T_A = +105\text{ °C}$	$\varepsilon_{SL105\text{ °C}}$	% of I_{PN}	-3.9		3.9	See formula note ¹⁾

Note: ¹⁾ $\varepsilon_{SL}(T_A) = \varepsilon_{SL25} + \left(TCS + \frac{TCI_{OE}}{I_{PN}} \right) \times |T_A - 25|$

At $T_A = 25\text{ °C}$, $U_C = +3.3\text{ V}$, $R_L = 10\text{ k}\Omega$ unless otherwise noted (see Min, Max, typ, definition paragraph in page 9).

Parameter	Symbol	Unit	Min	Typ	Max	Comment
Primary nominal RMS current	I_{PN}	A		32		
Primary current, measuring range	I_{PM}	A	-80		80	For $U_C = +3.3\text{ V} \pm 5\%$
Number of primary turns	N_P	-		1		
Resistance of primary jumper @ $T_A = 25\text{ °C}$	R_P	m Ω		0.21		
Resistance of primary jumper @ $T_A = 105\text{ °C}$	R_P	m Ω		0.29		T jumper = 120 °C
Supply voltage	U_C	V	3.135	3.3	3.465	
Current consumption	I_C	mA		19	25	
Reference voltage (output)	U_{ref}	V	1.63	1.65	1.67	Internal reference
Reference voltage (input)	U_{ref}	V	0.5		1.7	External reference
Output voltage range @ I_{PM}	$U_{out} - U_{ref}$	V	-1.15		1.15	Over operating temperature range
Internal series resistance of reference voltage	R_{ref}	Ω	130	200	300	series
Output internal resistance	R_{out}	Ω		2	5	series
Load capacitance	C_L	nF	0		6	
Electrical offset voltage referred to primary @ $I_P = 0$	U_{OE}	mV	-5		5	$U_{out} - U_{ref}$ @ $U_{ref} = 1.65\text{ V}$ Not guaranteed in REF IN mode with external reference $U_{ref} \neq 1.65\text{ V}$
Electrical offset current referred to primary	I_{OE}	mA	-348		348	
Temperature coefficient of U_{ref}	TCU_{ref}	ppm/K	-150		150	$-40\text{ °C} \dots 105\text{ °C}$
Temperature coefficient of U_{OE} referred to primary	TCU_{OE}	mV/K	-0.075		0.075	
Temperature coefficient of I_{OE} referred to primary	TCI_{OE}	mA/K	-5.22		5.22	
Nominal sensitivity	S_N	mV/A		14.375		460 mV @ I_{PN}
Sensitivity error	ε_S	%	-0.5		0.5	Factory adjustment
Temperature coefficient of S	TCS	ppm/K	-200		200	
Linearity error 0 ... I_{PN}	ε_L	% of I_{PN}	-0.5		0.5	
Linearity error 0 ... I_{PM}	ε_L	% of I_{PM}	-0.8		0.8	
Magnetic offset current (@ $10 \times I_{PN}$) referred to primary	I_{OM}	A	-0.25		0.25	
Delay time @ 10 % of the final output value for I_{PN} step	t_{D10}	μs			2	@ 50 A/ μs
Delay time @ 90 % of the final output value for I_{PN} step	t_{D90}	μs			2.5	@ 50 A/ μs
Frequency bandwidth (-3 dB)	BW	kHz		450		
RMS noise voltage spectral density referred to primary 100 Hz ... 100 kHz	u_{no}	$\mu\text{V}/\sqrt{\text{Hz}}$			5	
RMS noise voltage referred to primary DC ... 10 kHz DC ... 100 kHz DC ... 1 MHz	U_{no}	mVpp		4 10 16		
Sum of sensitivity and linearity @ I_{PN}	ε_{SL}	% of I_{PN}	-1		1	
Sum of sensitivity and linearity @ I_{PN} @ $T_A = +85\text{ °C}$	$\varepsilon_{SL 85\text{ °C}}$	% of I_{PN}	-3.2		3.2	See formula note ¹⁾
Sum of sensitivity and linearity @ I_{PN} @ $T_A = +105\text{ °C}$	$\varepsilon_{SL 105\text{ °C}}$	% of I_{PN}	-3.9		3.9	See formula note ¹⁾

Note: ¹⁾ $\varepsilon_{SL}(T_A) = \varepsilon_{SL 25} + \left(TCS + \frac{TCI_{OE}}{I_{PN}} \right) \times |T_A - 25|$

At $T_A = 25\text{ °C}$, $U_C = +3.3\text{ V}$, $R_L = 10\text{ k}\Omega$ unless otherwise noted (see Min, Max, typ, definition paragraph in page 9).

Parameter	Symbol	Unit	Min	Typ	Max	Comment
Primary nominal RMS current	I_{PN}	A		40		
Primary current, measuring range	I_{PM}	A	-100		100	For $U_C = +3.3\text{ V} \pm 5\%$
Number of primary turns	N_P	-		1		
Resistance of primary jumper @ $T_A = 25\text{ °C}$	R_P	m Ω		0.21		
Resistance of primary jumper @ $T_A = 105\text{ °C}$	R_P	m Ω		0.29		T jumper = 120 °C
Supply voltage	U_C	V	3.135	3.3	3.465	
Current consumption	I_C	mA		19	25	
Reference voltage (output)	U_{ref}	V	1.63	1.65	1.67	Internal reference
Reference voltage (input)	U_{ref}	V	0.5		1.7	External reference
Output voltage range @ I_{PM}	$U_{out} - U_{ref}$	V	-1.15		1.15	Over operating temperature range
Internal series resistance of reference voltage	R_{ref}	Ω	130	200	300	series
Output internal resistance	R_{out}	Ω		2	5	series
Load capacitance	C_L	nF	0		6	
Electrical offset voltage referred to primary @ $I_P = 0$	U_{OE}	mV	-5		5	$U_{out} - U_{ref}$ @ $U_{ref} = 1.65\text{ V}$ Not guaranteed in REF IN mode with external reference $U_{ref} \neq 1.65\text{ V}$
Electrical offset current referred to primary	I_{OE}	mA	-435		435	
Temperature coefficient of U_{ref}	TCU_{ref}	ppm/K	-150		150	$-40\text{ °C} \dots 105\text{ °C}$
Temperature coefficient of U_{OE} referred to primary	TCU_{OE}	mV/K	-0.075		0.075	
Temperature coefficient of I_{OE} referred to primary	TCI_{OE}	mA/K	-6.52		6.52	
Nominal sensitivity	S_N	mV/A		11.5		460 mV @ I_{PN}
Sensitivity error	ϵ_S	%	-0.5		0.5	Factory adjustment
Temperature coefficient of S	TCS	ppm/K	-200		200	
Linearity error 0 ... I_{PN}	ϵ_L	% of I_{PN}	-0.5		0.5	
Linearity error 0 ... I_{PM}	ϵ_L	% of I_{PM}	-0.8		0.8	
Magnetic offset current (@ $10 \times I_{PN}$) referred to primary	I_{OM}	A	-0.25		0.25	
Delay time @ 10 % of the final output value for I_{PN} step	t_{D10}	μs			2	@ 50 A/ μs
Delay time @ 90 % of the final output value for I_{PN} step	t_{D90}	μs			2.5	@ 50 A/ μs
Frequency bandwidth (-3 dB)	BW	kHz		450		
RMS noise voltage spectral density referred to primary 100 Hz ... 100 kHz	u_{no}	$\mu\text{V}/\sqrt{\text{Hz}}$			4.5	
RMS noise voltage referred to primary DC ... 10 kHz DC ... 100 kHz DC ... 1 MHz	U_{no}	mVpp		4 9 14		
Sum of sensitivity and linearity @ I_{PN}	ϵ_{SL}	% of I_{PN}	-1		1	
Sum of sensitivity and linearity @ I_{PN} @ $T_A = +85\text{ °C}$	$\epsilon_{SL85\text{ °C}}$	% of I_{PN}	-3.2		3.2	See formula note ¹⁾
Sum of sensitivity and linearity @ I_{PN} @ $T_A = +105\text{ °C}$	$\epsilon_{SL105\text{ °C}}$	% of I_{PN}	-3.9		3.9	See formula note ¹⁾

Note: ¹⁾ $\epsilon_{SL}(T_A) = \epsilon_{SL25} + \left(TCS + \frac{TCI_{OE}}{I_{PN}} \right) \times |T_A - 25|$

At $T_A = 25\text{ °C}$, $U_C = +3.3\text{ V}$, $R_L = 10\text{ k}\Omega$ unless otherwise noted (see Min, Max, typ, definition paragraph in page 9).

Parameter	Symbol	Unit	Min	Typ	Max	Comment
Primary nominal RMS current	I_{PN}	A		50		
Primary current, measuring range	I_{PM}	A	-125		125	For $U_C = +3.3\text{ V} \pm 5\%$
Number of primary turns	N_P	-		1		
Resistance of primary jumper @ $T_A = 25\text{ °C}$	R_P	m Ω		0.21		
Resistance of primary jumper @ $T_A = 105\text{ °C}$	R_P	m Ω		0.29		T jumper = 120 °C
Supply voltage ¹⁾	U_C	V	3.135	3.3	3.465	
Current consumption	I_C	mA		19	25	
Reference voltage (output)	U_{ref}	V	1.63	1.65	1.67	Internal reference
Reference voltage (input)	U_{ref}	V	0.5		1.7	External reference
Output voltage range @ I_{PM}	$U_{out} - U_{ref}$	V	-1.15		1.15	Over operating temperature range
Internal series resistance of reference voltage	R_{ref}	Ω	130	200	300	series
Output internal resistance	R_{out}	Ω		2	5	series
Load capacitance	C_L	nF	0		6	
Electrical offset voltage referred to primary @ $I_P = 0$	U_{OE}	mV	-5		5	$U_{out} - U_{ref}$ @ $U_{ref} = 1.65\text{ V}$ Not guaranteed in REF IN mode with external reference $U_{ref} \neq 1.65\text{ V}$
Electrical offset current referred to primary	I_{OE}	mA	-543		543	
Temperature coefficient of U_{ref}	TCU_{ref}	ppm/K	-150		150	-40 °C ... 105 °C
Temperature coefficient of U_{OE} referred to primary	TCU_{OE}	mV/K	-0.075		0.075	
Temperature coefficient of I_{OE} referred to primary	TCI_{OE}	mA/K	-8.15		8.15	
Nominal sensitivity	S_N	mV/A		9.2		460 mV @ I_{PN}
Sensitivity error	ϵ_s	%	-0.5		0.5	Factory adjustment
Temperature coefficient of S	TCS	ppm/K	-200		200	
Linearity error 0 ... I_{PN}	ϵ_L	% of I_{PN}	-0.5		0.5	
Linearity error 0 ... I_{PM}	ϵ_L	% of I_{PM}	-0.8		0.8	
Magnetic offset current (@ $10 \times I_{PN}$) referred to primary	I_{OM}	A	-0.25		0.25	
Delay time @ 10 % of the final output value for I_{PN} step	t_{D10}	μs			2	@ 50 A/ μs
Delay time @ 90 % of the final output value for I_{PN} step	t_{D90}	μs			2.5	@ 50 A/ μs
Frequency bandwidth (-3 dB)	BW	kHz		450		
RMS noise voltage spectral density referred to primary 100 Hz ... 100 kHz	u_{no}	$\mu\text{V}/\sqrt{\text{Hz}}$			4	
RMS noise voltage referred to primary DC ... 10 kHz DC ... 100 kHz DC ... 1 MHz	U_{no}	mVpp		3.3 7.3 12		
Sum of sensitivity and linearity @ I_{PN}	ϵ_{SL}	% of I_{PN}	-1		1	
Sum of sensitivity and linearity @ I_{PN} @ $T_A = +85\text{ °C}$	$\epsilon_{SL85\text{ °C}}$	% of I_{PN}	-3.2		3.2	See formula note ¹⁾
Sum of sensitivity and linearity @ I_{PN} @ $T_A = +105\text{ °C}$	$\epsilon_{SL105\text{ °C}}$	% of I_{PN}	-3.9		3.9	See formula note ¹⁾

Note: ¹⁾ $\epsilon_{SL}(T_A) = \epsilon_{SL25} + \left(TCS + \frac{TCI_{OE}}{I_{PN}} \right) \times |T_A - 25|$

Maximum continuous DC current

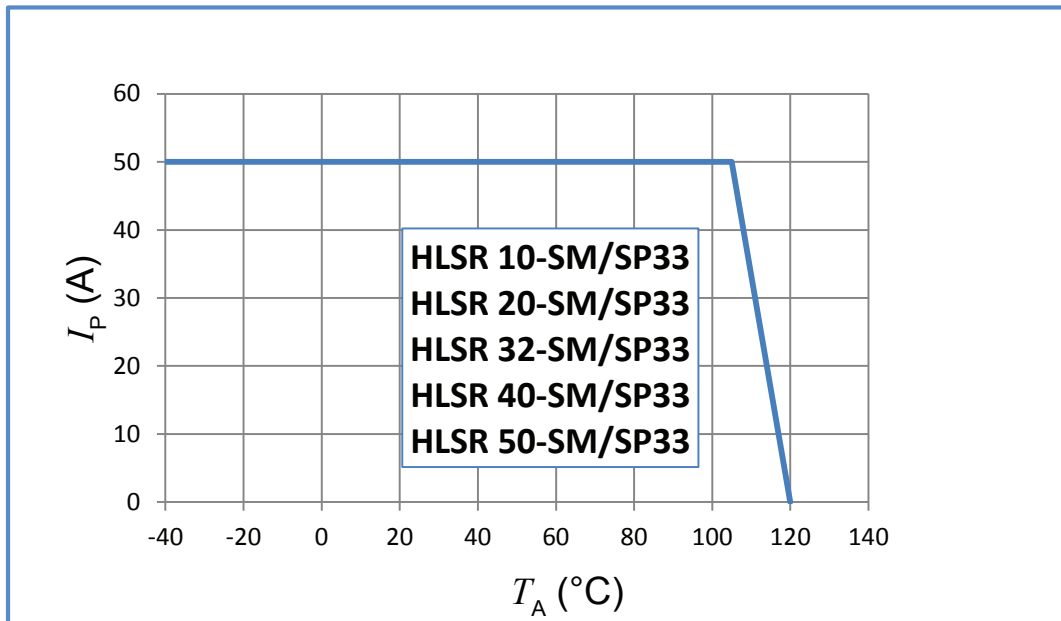

Important notice: whatever the usage and/or application, the transducer jumper temperature shall not go above the maximum ratings of 120 °C as stated in page 2 of this datasheet.

Definition of typical, minimum and maximum values

Minimum and maximum values for specified limiting and safety conditions have to be understood as such as well as values shown in “typical” graphs.

On the other hand, measured values are part of a statistical distribution that can be specified by an interval with upper and lower limits and a probability for measured values to lie within this interval.

Unless otherwise stated (e.g. “100 % tested”), the LEM definition for such intervals designated with “min” and “max” is that the probability for values of samples to lie in this interval is 99.73 %.

For a normal (Gaussian) distribution, this corresponds to an interval between -3 sigma and +3 sigma. If “typical” values are not obviously mean or average values, those values are defined to delimit intervals with a probability of 68.27 %, corresponding to an interval between -sigma and +sigma for a normal distribution.

Typical, minimum and maximum values are determined during the initial characterization of the product.

Measuring range versus external reference voltage

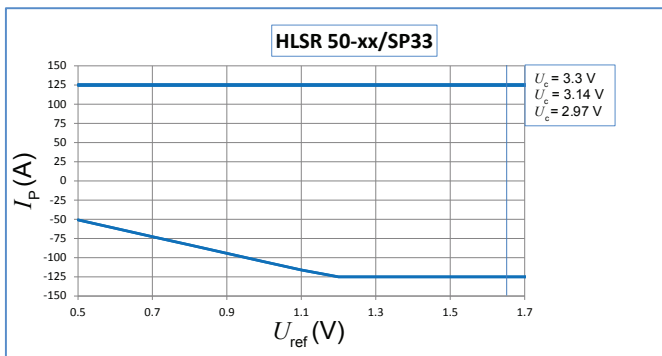
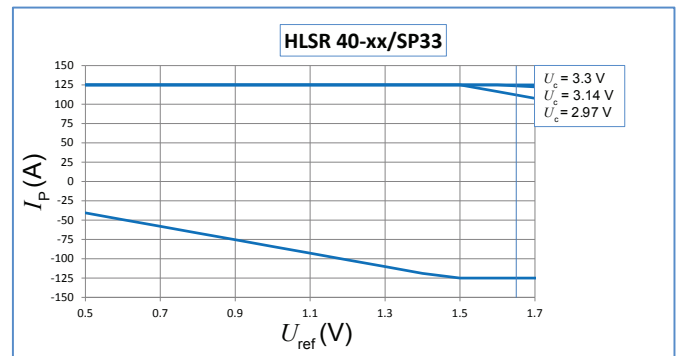
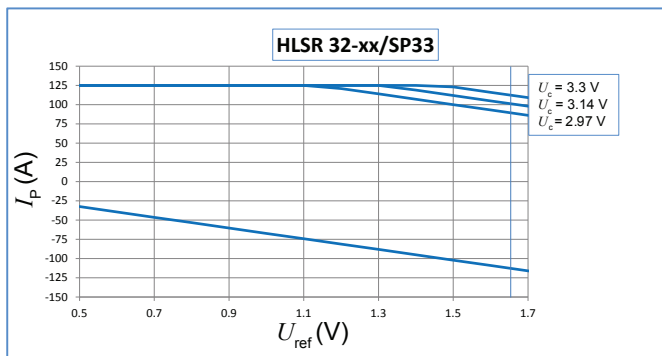
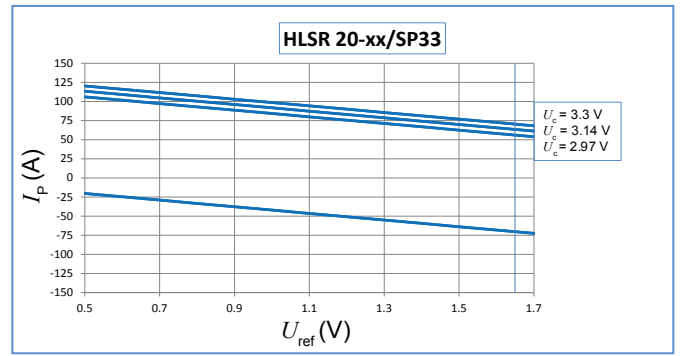
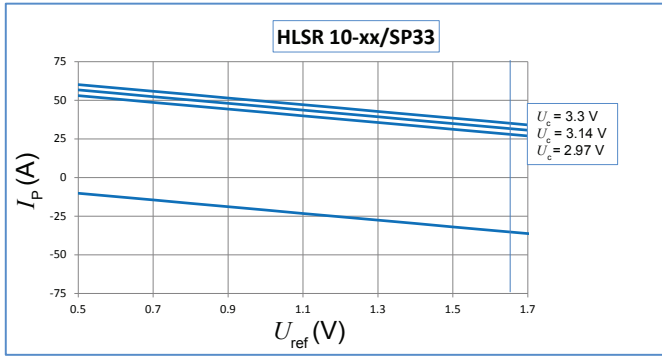

PCB footprint (in mm)

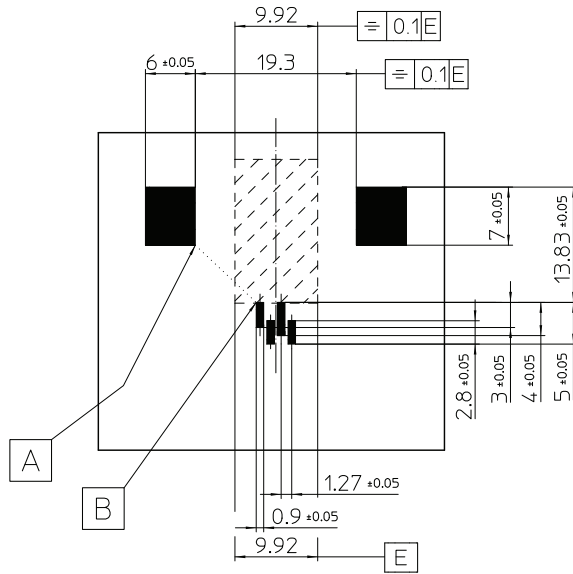

Recommended PCB layout based on a stencil thickness of 150µm (.006 inch)

	d_{Cl} (mm)	d_{Cp} (mm)
A-B	10	10

Assembly on PCB

- Pb free reflow profile
- No clean process only

Safety

This transducer must be used in limited-energy secondary circuits according to IEC 61010-1.



This transducer must be used in electric/electronic equipment with respect to applicable standards and safety requirements in accordance with the manufacturer's operating instructions.



Caution, risk of electrical shock.

When operating the transducer, certain parts of the module can carry hazardous voltage (eg. primary busbar, power supply). Ignoring this warning can lead to injury and/or cause serious damage. This transducer is a build-in device, whose conducting parts must be inaccessible after installation. A protective housing or additional shield could be used. Main supply must be able to be disconnected.

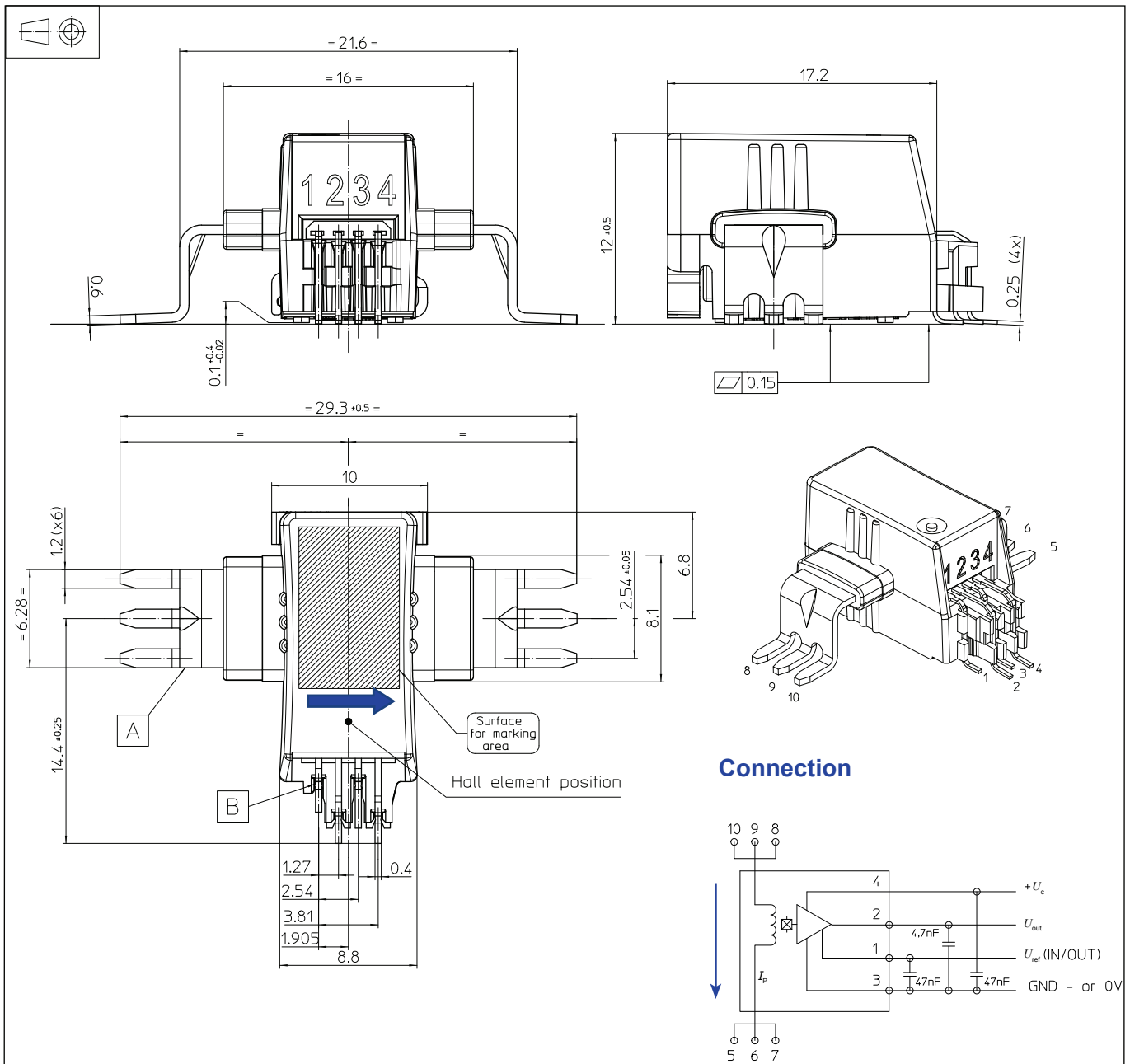
Dimensions (in mm. General linear tolerance ± 0.2 mm)

Remarks

- U_{out} is positive with respect to U_{ref} when positive I_p flows in direction of the arrow shown on the drawing above.
- Installation of the transducer must be done, unless otherwise specified on the datasheet, according to LEM Transducer Generic Mounting Rules. Please refer to LEM document N°ANE120504 available on our Web site: <https://www.lem.com/en/file/3137/download/>.